

Panelicity® Series 36

User Manual

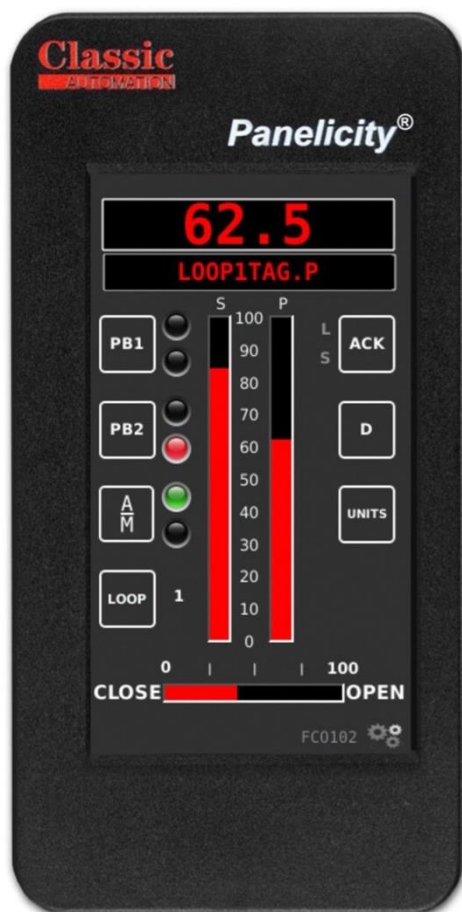

Panelicity® is a registered trademark of Classic Automation LLC

<i>Panelicity® Series 36</i> Introduction	4
Control Strategies Brief Descriptions.....	4
1.0 Display Types.....	5
2.0 Power Up Display.....	6
3.0 Common Operation Displays	7
3.1 Main Menu Display	7
3.2 Security Settings Display	8
3.3 Process Alarms Display	9
3.4 Totalizer Display.....	11
3.5 Data Functions	13
Displaying Trends.....	14
Change Trend Time	17
Viewing Stored Data in a Tabular Format.....	18
4.0 Control Display - Type A.....	21
4.1 PID Analog Output	21
4.2 On/Off Control Digital Output	22
Priorities.....	24
4.3 Change Local Setpoint.....	26
4.4 Remote Setpoint	28
4.5 Change Output.....	30
5.0 Control Display - Type B.....	32
5.1 PID Analog Output	32
5.2 On/Off Control Digital Output	33
Priorities.....	34
5.3 Change Local Setpoint.....	36
5.4 Remote Setpoint	38
5.5 Change Output.....	42
6.0 Support.....	44
7.0 Control Strategies Details	45
FCO101 - Single Loop Controller w/ Tracking Setpoint.....	46
FCO102 - Single Loop Controller w/ Fixed Setpoint.....	47
FCO103 - External Set Controller w/ Tracking Local Setpoint.....	48
FCO104 - External Set Controller w/ Non-Tracking	49

Local Setpoint.....	49
FCO105 - Ratio Set Control w/ Operator Setpoint Limits	50
FCO106 - Single Loop Controller w/ Operator Setpoint Limits	51
FCO107 - Dual Loop Controller	52
FCO121 - Cascade Control.....	53
FCO122 - Cascade Control w/ Operator Setpoint Limits	54

Panelicity® Series 36 Introduction

This manual describes the Operation Displays and Control Strategies. It is assumed that the Controller has been setup. Refer to the **Panelicity® Series 36 Setup Guide** for more details on setting up the Controller.

The Controller uses one of two Display Types (Type A or Type B) and one of nine Control Strategies.

Consult with whomever Setup the Controller to determine which Display Type and Control Strategy have been selected.

Write down the Display Type and Control Strategy:

Display Type (A or B)

Control Strategy

Knowing the Display Type and Control Strategy allows you to focus on the appropriate Operator Display and Control Strategy Details later in this manual. The controller is activated at the factory and loaded with operating software.

Control Strategies Brief Descriptions

FCO101	Single Loop Control w/ Tracking Setpoint
FCO102	Single Loop Control w/ Fixed Setpoint
FCO103	External Set Control w/ Tracking Local Setpoint
FCO104	External Set Control w/ Non-Tracking Local Setpoint
FCO105	Ratio Set Control w/ Operator Setpoint Limits
FCO106	Single Loop Control w/ Operator Setpoint Limits
FCO107	Dual Loop Control
FCO121	Cascade Control
FCO122	Cascade Control w/ Operator Setpoint Limits

More detailed descriptions are available in the *Control Strategies Details* chapter in this manual and in the **Panelicity® Setup Guide**.

1.0 Display Types

Type A

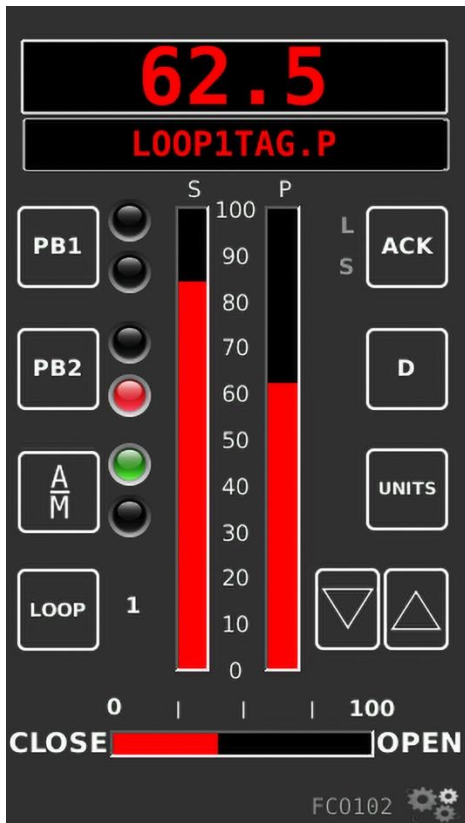

Type B

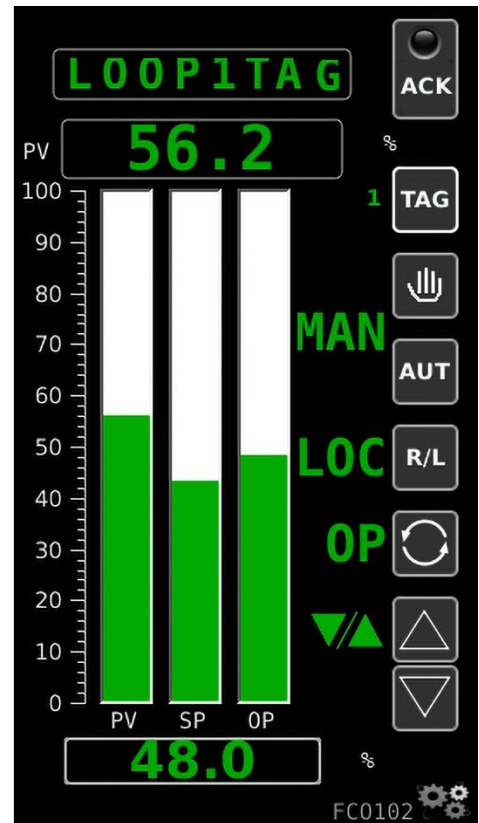

2.0 Power Up Display

Upon controller power up and during initialization, the Display shows the **Panelicity® Series 36** logo.

After initialization, the Controller opens the *Control Display*.



3.0 Common Operation Displays

3.1 Main Menu Display

Select the **Gear** icon in the lower right corner of the *Control Display* to open the *Main Menu Display*. The appearance of the *Main Menu Display* changes based on the Security Access Level. There are four (4) Security Access Levels. Users have the ability to perform additional functions with increasing Security Access Authorization. Operate Access Level is the default and the *Main Menu Display* below is displayed until a user logs in. Select Security to open the *Security Settings Display* and login. The *Totalizer Display* is only visible if the Totalizer **ENABLE** parameter in the *TOTALIZER Setup* was set to YES. Refer to the *Panelicity® Setup Guide*.



Main Menu Display
Operate Access Level



3.2 Security Settings Display

Select **Security** on the *Main Menu Display* to open the *Security Settings Display*. The *Security Settings Display* allows a user to Log In and enter a password to attain elevated security. Refer to the *Security Settings Display* in the **Panelicity® Setup Guide**.



Select the **Left Display Arrow**  or the **Home Icon**  to open the *Main Menu Display*.

3.3 Process Alarms Display

To open the *Process Alarms Display* either select **ACK** on an active or unacknowledged alarm on the *Control Display* or select **Alarms** on the *Main Menu Display*.

Dual Loop Control or Cascade Control (Dual Loop shown)

The screenshot shows the 'Process Alarms' interface with two loop sections. Each loop has a 'QUAL' indicator and an 'ACK' button. The first loop, LOOP1TAG.P, shows a value of 0.0%. The second loop, LOOP2TAG.P, shows a value of 50.0%. Each loop has four associated alarms (ALM1_A1-4 and ALM2_A1-4). The status LEDs for ALM1_A1, ALM1_A2, and ALM1_A3 are red, indicating they are active. The LEDs for ALM1_A4, ALM2_A1, ALM2_A2, ALM2_A3, and ALM2_A4 are black, indicating they are disabled. The text 'Alarm Disabled' is written to the left of the screen, with red lines pointing to the grayed-out ALM1_A4 and ALM2_A4 entries.

Loop	Alarm Name	Type	Priority	Value	Status LED	ACK
LOOP1TAG.P	ALM1_A1	HI	P3	110.0	Black	ACK
	ALM1_A2	LO	P3	-10.0	Red	ACK
	ALM1_A3	dEV	P3	100.0	Black	ACK
	ALM1_A4	none	P3	0.0	Black	ACK
LOOP2TAG.P	ALM2_A1	HI	P3	110.0	Black	ACK
	ALM2_A2	LO	P3	-10.0	Black	ACK
	ALM2_A3	dEV	P3	100.0	Black	ACK
	ALM2_A4	none	P3	0.0	Black	ACK

The *Process Alarms Display* shows the Alarm Tagname, input value, Type, Priority, Limit, and Status LED. The second alarm group applies to either a remote input (X) in a single loop strategy, or to the process input (P) of a second loop. The alarm names (defaults **ALM1_A1**, **ALM1_A2**, **ALM1_A3**, **ALM1_A4**, **ALM2_A1**, **ALM2_A2**, **ALM2_A3**, or **ALM2_A4**) will be grayed if the alarm is disabled. Refer to the **Enable Alarm** parameter in the *Alarms Setup Display* section of the *Panelicity® Setup Guide*.

There is a built-in Data Quality alarm which displays a red LED to the right of **QUAL** for Bad Quality. Bad Quality is triggered when the input value exceeds the upper or lower range value by more than 10%. This alarm is handled as a Priority 1 Alarm that needs to be acknowledged. Note that it is possible to have both a process alarm and bad quality alarm simultaneously as shown in the above *Process Alarms Display*. Bad Quality also shows values on the *Control Display* as follows: for mA and V inputs, the value is the minimum or maximum values defined by Characterizers 1 and 2; for thermocouple and RTD inputs, the value is the top range value. Refer to *Character Setup Display* section of the **Panelicity® Setup Guide**. For thermocouple and RTD inputs the *Control Display* shows the top of range value.

Status LED - A Solid Red LED indicates that the alarm is active in the displayed loop. A Flashing Red LED indicates that the alarm needs to be acknowledged.

Select  to the right of a Flashing LED to acknowledge that alarm.

GLOBAL LED - the global alarm is an inbuilt alarm that is active if any process alarm or quality alarm in either loop is active. Acknowledging the global alarm acknowledges all process and quality alarms in both loops. The global alarm and global alarm acknowledge are accessible via MODBUS.

Select the **Left Display Arrow**  to open the previous display.

3.4 Totalizer Display

The *Totalizer Display* is only visible if the **Enable** parameter in the TOTALIZER Setup was set to YES. Refer to the **Enable** parameter on the *Totalizer Setup Display* in the *Panelicity Setup Guide*.

The screenshot shows the 'Totalizer' display interface. On the left, labels with red lines point to specific elements: 'AI Number' points to 'AIN1', 'AI Value' points to '50.0', 'AI Units' points to 'GAL /m', 'Timebase' points to 'TOT SCALE', 'Preset Status LED' points to 'BATCH TOTAL', and 'Preset Limit' points to 'PRESETS'. On the right, labels with red lines point to: 'Totalizer Total RunTime' (pointing to 'RunTotal Time 00:08:38'), 'Start/Stop Totalizing' (pointing to 'START'), 'Reset BATCH TOTAL to Initial Value' (pointing to 'RESET'), 'Reset RUN TOTAL to Initial Value' (pointing to 'RESET'), 'Preset Number' (pointing to '1' and '2'), and 'PULSE OUT LED' (pointing to 'PULSE OUT'). The interface includes a 'START' button, two 'RESET' buttons, and two LED indicators labeled '1' and '2'. The 'PULSE OUT' LED is currently black.



The *Totalizer Display* shows the Totalizer Total RunTime, the value of the Analog Input, the TOT SCALE, the value of the BATCH TOTAL, the value of the RUN TOTAL, and the status of the Pulse Output (green LED). Note that the PULSE OUT LED is not capable of keeping up with the pulse output but does indicate that the totalizer is running. The BATCH TOTAL can be reset by an operator. The RUN TOTAL requires TUNE or higher security access to reset. Resetting the RUN TOTAL also resets the RunTotal Time and resets the BATCH TOTAL.

PRESETS 1 and 2 statuses are displayed as LED's. Green indicates the PRESET has been reached. Black indicates the PRESET has not yet been reached.

Select **Start** or **Stop** Totalizing to start or stop totalization. The text toggles START or STOP. When a totalizer stopped, the pulse output and preset outputs are held at their last states.

RESET BATCH TOTAL - resets the BATCH TOTAL to the Initial Value.

RESET RUN TOTAL - resets the RUN TOTAL to the Initial Value. TUNE or higher security is required to reset the RUN TOTAL. Resetting the RUN TOTAL also resets the BATCH TOTAL as well as the RunTotal Time.



The **Left Display Arrow**  opens the last display or the **Home Icon**  to open the *Main Menu Display*.

3.5 Data Functions

Select **Data** on the *Main Menu Display* to open the *Data Functions Menu Display*.

Data Functions Menu



Logging Status (**OFF** or **ON**) is shown to the right of Logging at the top of the display. Tune or higher Security Access is required to turn logging on or off. Select the **Home** icon  to return to the Main Menu or select the **Back Arrow**  to return to the last display.

Displaying Trends

Select **TREND** on the *Data Functions Menu Display* to open the *TREND SELECTOR Display*.

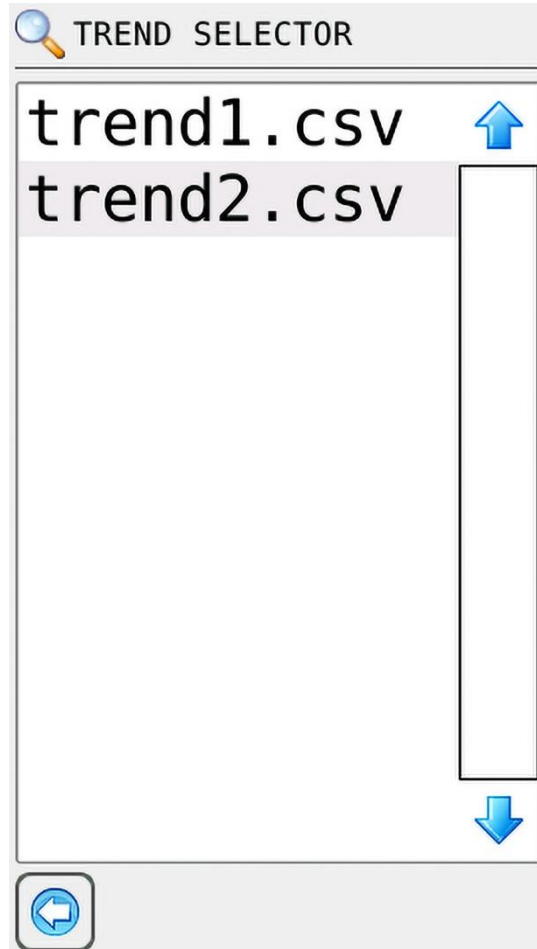

Select either trend1.csv for Loop1 or Trend2.csv for Loop2 to open the *Trend Display* for that loop.

Trend Display Loop1

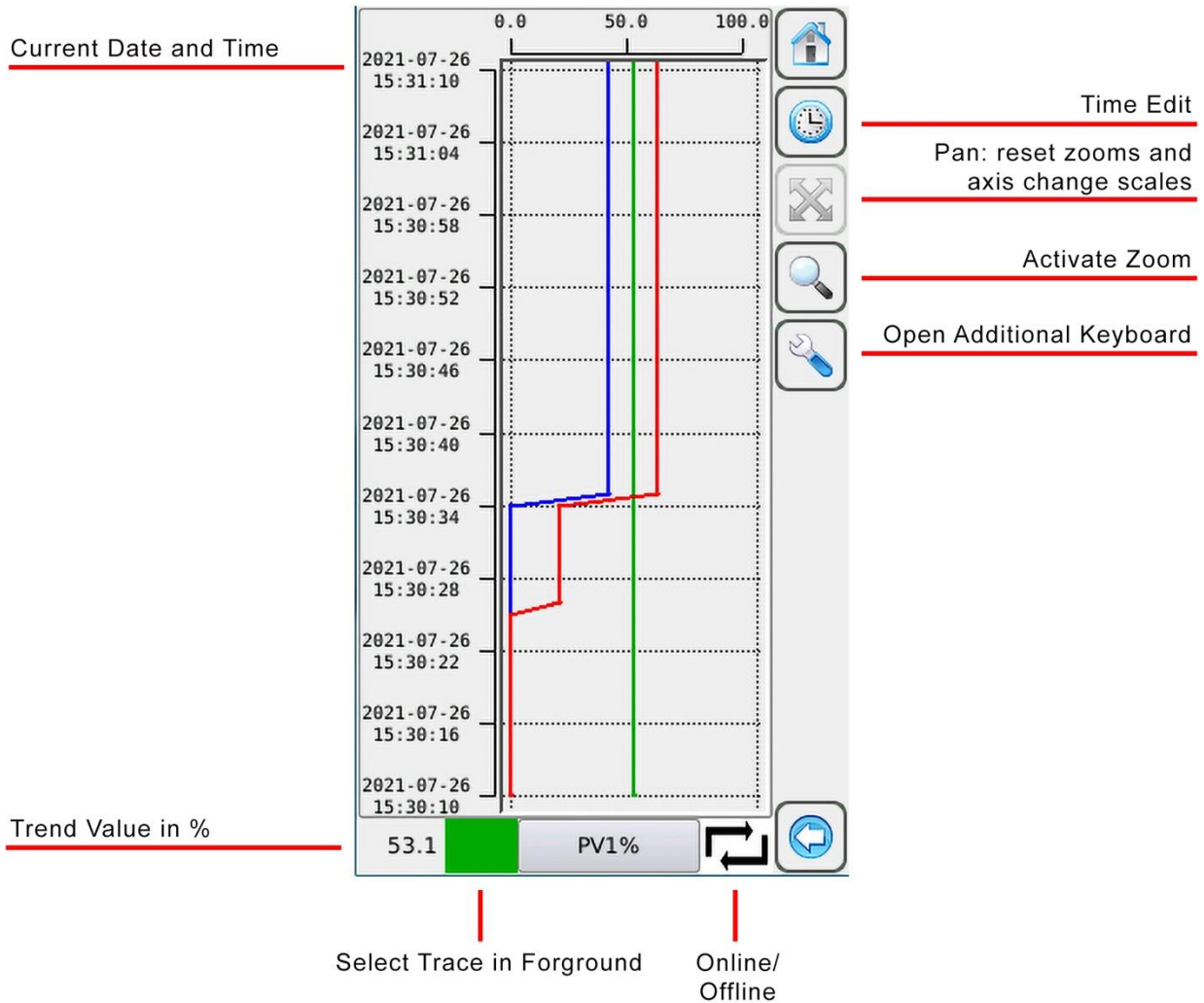

Three (3) traces are displayed, PV, SP, and OP.

The *trend display* works in 2 ways:





Online: graph shifts automatically to always show the latest samples



Offline: graph is static even when new samples are available. They will be shown only if in the actual display window.

When the *Trend Display* is first opened, the traces shown are real time (on-line).

Occasionally an hourglass will be shown where the  or  symbols appear. The hourglass indicates that the *trend display* is buffering data to display.







There are twelve (12) data values logged, six (6) of which are used for trends.

The default trend window is 60 seconds with 6 second intervals.

To zoom an area, select the magnifying glass and select an area on the touchscreen.

Select the wrench to open an additional keyboard. Select the wrench again to close the additional keyboard.

Additional Keyboard

	shift forward time axis
	shift back time axis
	shift up values axis
	shift down values axis
	On/off line: enable/disable online mode
	saves on panel the actual screenshot

Up and down keys are enabled only if there are values outside the displayed range.

Change Trend Time

Select  **TimeEdit** on the *Trend Display* to open the *Trend Time Edit Display*. Refer to *Data Functions Menu Display*.

Trend Display Loop1

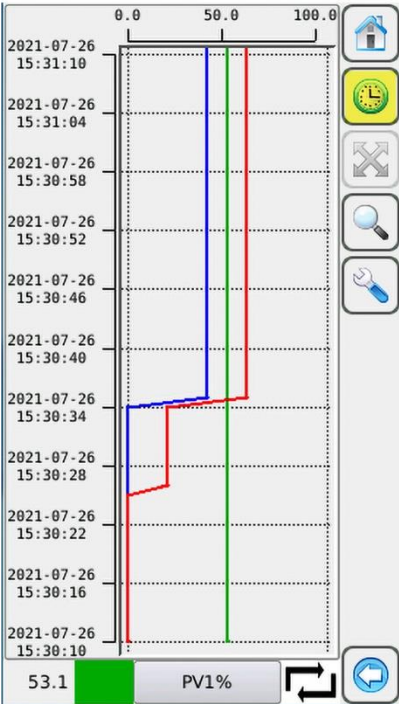

Trend Time Edit Display



Modifying any of the time axis ranges changes the settings for all traces. Modifying the value axis ranges changes the setting for the active trace only. These values are not saved so they are lost when the actual trend display is closed.

Select the **Back Arrow**  to return to the *Trend Display*.

Viewing Stored Data in a Tabular Format

Select STORE on the *Data Functions Menu Display* to open the *STORE FILTER SELECTOR Display*. Refer to *Data Functions Menu Display*.

Store Filter Selector Display

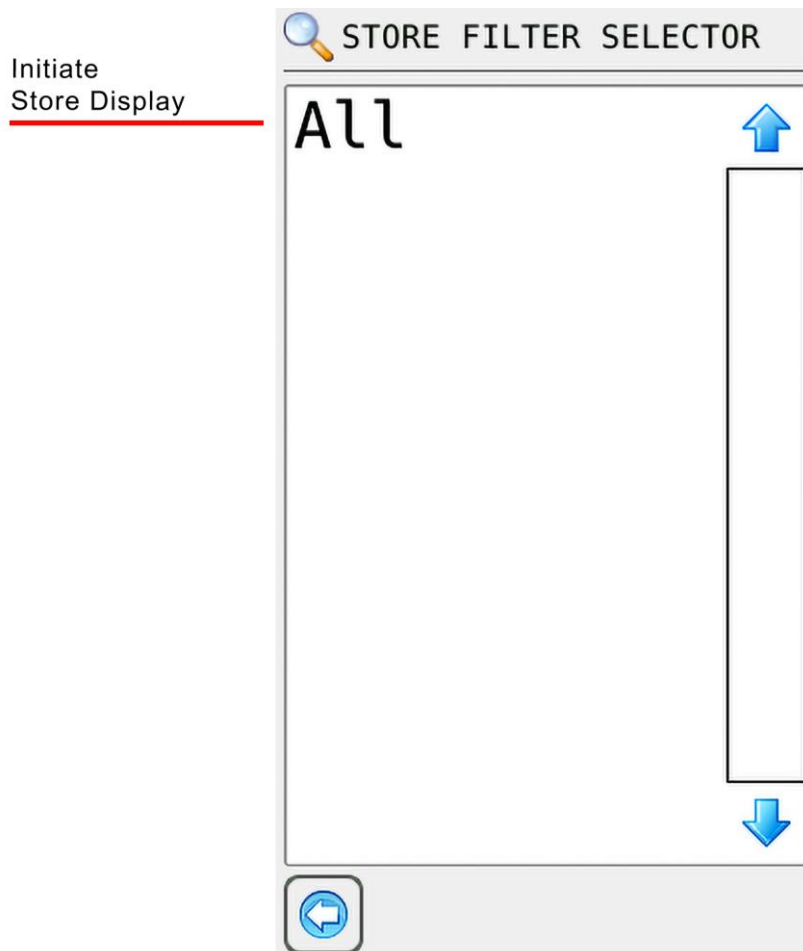

Select **All** to initiate the *data storage display* creation. **Loading** will be displayed while the display is being created. On completion the *Log Store Complete Display* will open. The loops PV, SP, and OP, and other data can be viewed in a tabular format.

Log Store Complete Display

STORE 2023/03/31 - 14:10:40

Filter: [2023/03/31_00:00:00 - 2023/03/31_

date	time	P1Pct	P2Pct	P3Pct
2023/03/31	13:44:26	0.0	0.0	0.0
2023/03/31	13:44:27	0.0	0.0	0.0
2023/03/31	13:44:28	0.0	0.0	0.0
2023/03/31	13:44:30	0.0	0.0	0.0
2023/03/31	13:44:31	0.0	0.0	0.0
2023/03/31	13:44:32	0.0	0.0	0.0
2023/03/31	13:44:33	0.0	0.0	0.0
2023/03/31	13:44:34	0.0	0.0	0.0
2023/03/31	13:44:35	0.0	0.0	0.0
2023/03/31	13:44:36	0.0	0.0	0.0
2023/03/31	13:44:37	0.0	0.0	0.0
2023/03/31	13:44:38	0.0	0.0	0.0

Navigation icons: Home, Refresh, Filter, Up, Down, Left, Right, USB

Tabular Data Explained	
Date	Date as year/month/day
Time	Time as hour:minute:second
AM1_AUTO	Loop1 Mode (AUTO or MANUAL), 0=MANUAL, 1=AUTO
AM2_AUTO	Loop2 Mode (AUTO or MANUAL), 0=MANUAL, 1=AUTO
SETPT1_O1	Loop 1 Setpoint Value in EU
SETPT2_O1	Loop 2 Setpoint Value in EU
P1Pct	Loop 1 Process Value in %
P2Pct	Loop 2 Setpoint Value in %
PROCESS1	Loop 1 Process Value in EU
PROCESS2	Loop 2 Process Value in EU
S1Pct	Loop 1 Setpoint Value in %
S2Pct	Loop 2 Setpoint Value in %
V1Pct	Loop 1 Output Value in %
V2Pct	Loop 2 Output Value in %
PW_Lev	Access Level (0, 1, 2, 3, 4)

4.0 Control Display - Type A

This is the primary Display for the operator.

4.1 PID Analog Output

PID Analog Output

Operate Display Auto Mode
Process Shown in Numeric Display

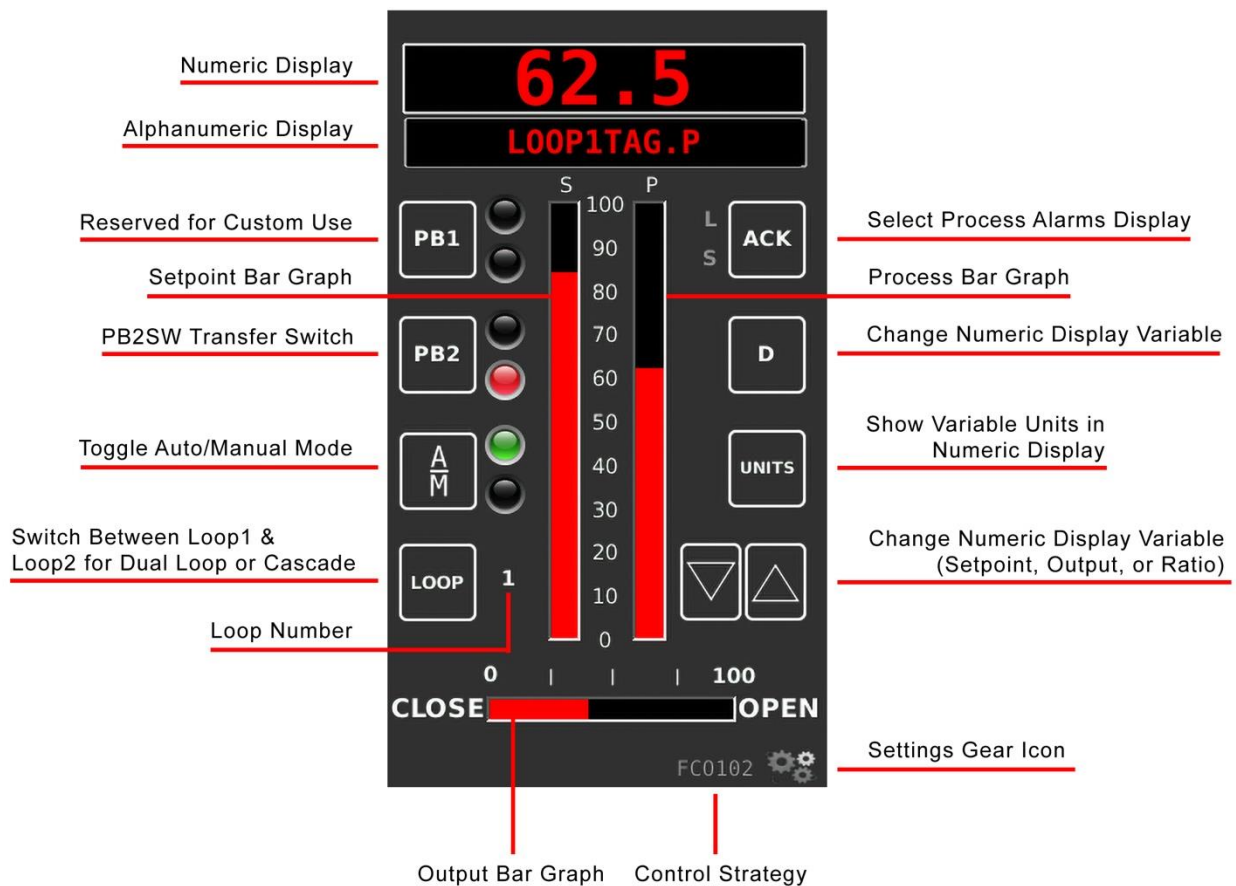

4.2 On/Off Control Digital Output

ON/OFF Control Digital Output
Operate Display Auto Mode
Output Shown in Numeric Display

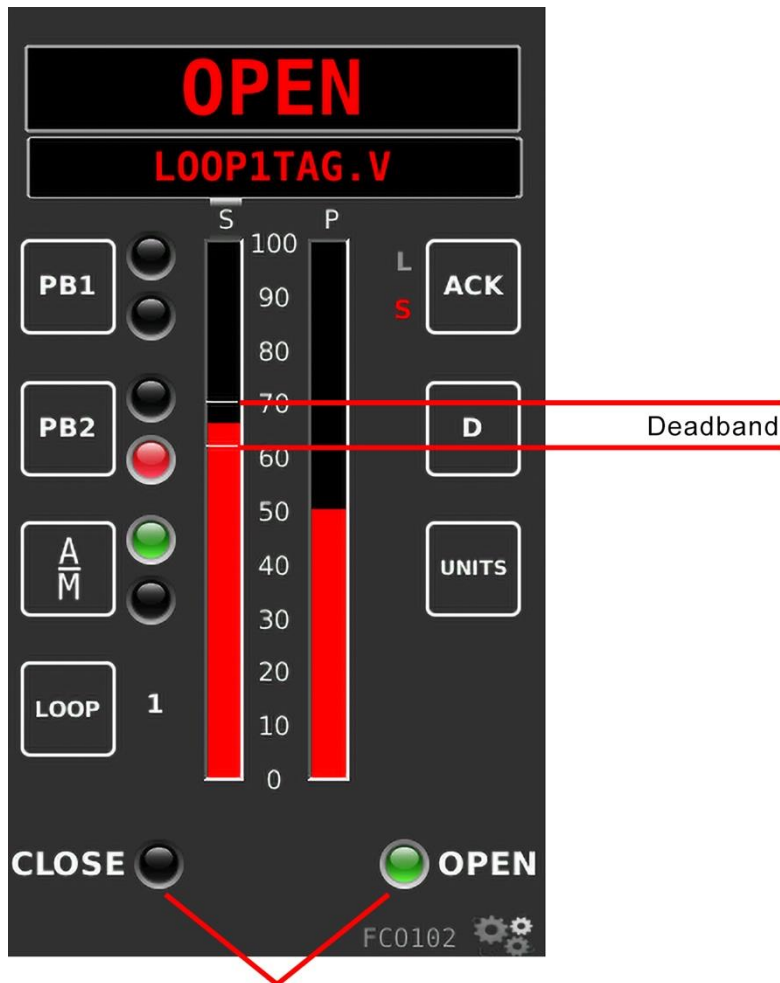

ON/OFF Control Digital Output Status

6-Digit Numeric Display - displays the numeric value of the variable identified by the 10-character alphanumeric display. Supports up to 6 significant digits, regardless of the decimal point position. Examples: -999999 to 999999, -9999.99 to 9999.99. Any input exceeding limits flashes and shows as the maximum or minimum displayable value.

10-Character Alphanumeric Display - displays the Loop Tag with the dot suffix of the variable currently showing in the 6-digit numeric display (e.g. **TC2053.P** is the **P**rocess variable for loop **TC2053**). A Loop Tag that is displayed is called the *Active Loop* and all operator controls (e.g. PB1, PB2, A/M, ACK, D, UNITS) will affect the function blocks within the *Active Loop*. The most recent highest priority Unacknowledged alarm will be displayed for 2 seconds and alternates with the Loop Tag variable.

PB1 - reserved for custom use.

PB2 - controls the operation of the **PB2SW** (**PB 2** transfer **SW**itch) function block when the block has been configured for use within the *Active Loop*. Refer to the *Control Strategies Details* chapter for more information on **PB2SW**. The color of the LED located to the right of **PB2** is red for local setpoint and green for remote setpoint.

A/M - controls the operation of an **A/M** (**A**uto/**M**anual) function block. There are 2 status LEDs located to the right. These LEDs indicate the status of the function block. When the A/M is switched to Auto the numeric display shows the Setpoint Value as indicated by **.S** in the alphanumeric display. The color of the LED located to the upper right of **A/M** changes to green. The Setpoint Value can be adjusted using the **Up/Down Arrows** or by selecting the numeric display and entering a value using the Setpoint Data Entry Display (if the *Data Entry Displays* were enabled during Setup). When the A/M is switched to Manual, the numeric display shows the Output value as indicated by **.V** in the alphanumeric display. The color of the LED located to the lower right of **A/M** changes to red. The Output Value can be adjusted using the **Up/Down Arrows** or by selecting the numeric display and entering a value using the *Output Keypad Display* (if keypad entry was enabled during on *Factory Options Display*).

LOOP - selects the *Active Loop* when more than one loop has been configured. The **LOOP** advances the operator display to the next *Active Loop*. All operator controls will affect the *Active Loop* that is currently shown in the alphanumeric display (e.g. **FC2367**). When a loop is first displayed, the Loop Tag will appear in the alphanumeric field and the displayed variable will be the same as when the loop was last viewed.

ACK - is used together with the **L** and **S** status LEDs to manage alarms. Alarms are assigned priorities 1-5 (with 1 the highest) and are organized within the controller, first by priority and then by order of occurrence. The Status Indicator lights **L** and **S** are used to indicate alarm status. **ACK** opens the *Alarm Display*.

S Status LED - Indicates that there is an alarm (including bad data quality) for a loop other than the one currently displayed.

L Status LED - Indicates that an alarm (including bad data quality) is active in the displayed Loop. A flashing LED indicates that the alarm needs to be acknowledged.

Priorities

Priority 1 High Priority - causes the Controller bar graphs and LEDs to flash and requires acknowledgement to stop flashing. This is the highest priority.

Priority 2 - also flashes the bar graphs but stops flashing when the alarm clears. (e.g. self-clearing)

Priority 3 - also causes the alarm LEDs to flash and stops when the alarm is acknowledged.

Priority 4 - causes the alarm LEDs to flash but stops when the alarm clears.

Priority 5 - displays the alarm but does not require acknowledgement. This is the lowest priority.

If the alarm is in the active loop, the alphanumeric display will alternate between the loop tag and the unacknowledged condition (e.g. 'TC2053.P' <---> 'A3 HI'). To open the *Process Alarms Display*, select **ACK**. Refer to the *Process Alarms Display*.

D - changes the variable displayed in the numeric display. Select **D** to advance the variable displayed in the sequence P, S, V, X, Y, and R from any starting point within the display select group. Note: X, Y, and R variables will only appear for certain Control Strategies. The X, Y, and R values can also be selected (and possibly changed) if they apply to the selected Control Strategy.

UNITS - displays the units of the variable shown in the alphanumeric display. The units that apply to the displayed variable will appear in the alphanumeric (e.g. 'TC2053.P' 'deg F', 'TC2053.V' 'PRCT'). After 3 seconds, the alphanumeric display will return to the variable tag.

S Bar graph - this vertical bar graph displays the scaled range of the controller setpoint in the *Active Loop*.

Bar graph height shows the setpoint as the % of range value. Select **D** to display the setpoint in engineering units in the numeric display, the dot S parameter (e.g. **TC2053.S**).

Deadband Indication - these horizontal lines indicate the deadband for ON/OFF Control Digital Outputs.

Deadband is the hysteresis as a % for ON/OFF control. For example, AI1 range 0 to 200F, deadband = 4%, Direct Mode, setpoint = 100F. DO goes ON below 96 °F and OFF above 104 °F. This is similar to a home thermostat.

P Bar graph - this vertical bar graph displays the scaled range of the controller process in the *Active Loop*.

Bar graph height shows the process as the % of range value. Select **D** to display the process in engineering units in the numeric display, the dot P parameter (e.g. **TC2053.P**).

Up/Down Arrows - use the Up and Down arrows to change the value in the numeric display (e.g. **Setpoint**, **Output**, or other variable configured for normal operator display changes such as **Ratio**). The rate of change of the value increases if you depress and hold the arrow. **Up/Down Arrows** are only visible if it is possible to change the value in the numeric display.

V Bar graph - PID control analog outputs, this horizontal bar graph displays the scaled range of the controller output in the *Active Loop*. The output signal is shown as the % of range value. Select **D** to display the output in engineering units in the numeric display, the dot V parameter (e.g. **TC2053.V**). For ON/OFF Control digital outputs, CLOSE or OPEN will be displayed.

Gear Icon - Select to open the *Main Menu Display*.

4.3 Change Local Setpoint

This section applies to the Local setpoint. The remote setpoint (if part of the control strategy) can be viewed but not changed by an operator.

To change the Local Setpoint - Use Up/Down Arrows or Keypad Entry

PID Analog Output
Operate Display Auto Mode
Local Setpoint shown in
Numeric Display

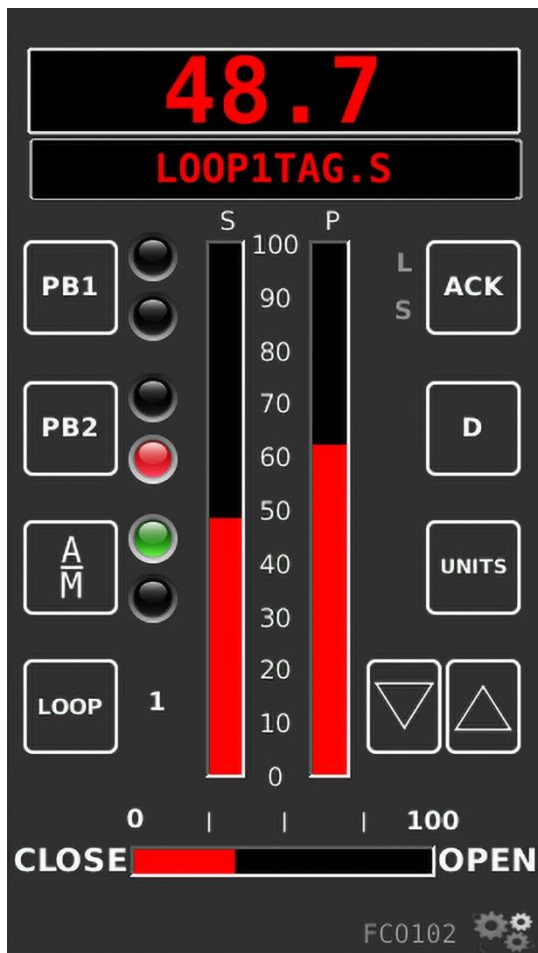

The LED to the right of  indicates the controller mode, red for manual, green for auto. Select A/M to change the mode to auto.

Select  to display *LOOP1TAG.S* in the numeric display.

Use the Up/Down Arrows  to increase or decrease the Setpoint. The rate of change of the value increases if you depress and hold the arrow.

To enter a local setpoint value using the keypad, select the Numeric Display to Open the *Keypad Display* (if keypad entry was enabled during Setup.)

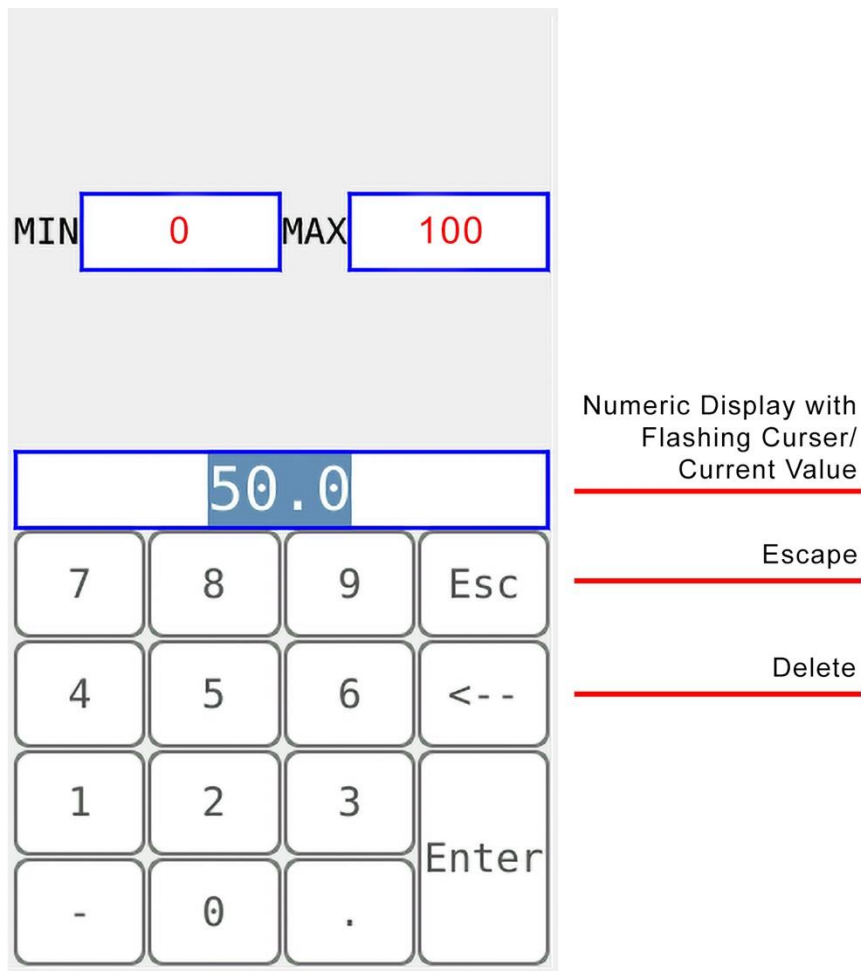
Keypad

The **current value** is backlit and highlighted on the Numeric Display. The Cursor flashes to the right of the current value. Select Characters on the keypad to input data.

Select **Escape** to ignore the characters selected to return to the *Control Display*.

Select the **Delete** < - - Character to delete the last character selected and move the cursor to the left.

Note that the **MIN** and **MAX** values may be different for your control strategy.

Select **Enter** after you have input all the characters to return to the *Control Display*.

4.4 Remote Setpoint

The remote setpoint (if used in the control strategy) can be viewed but not changed by an operator.

Select **D** to change the value displayed in the numeric display to **X** (remote setpoint) as shown:

**Auto Local Setpoint
View Active Setpoint**

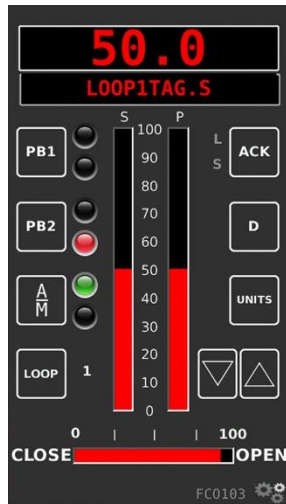

Select

**Auto Local Setpoint
View Remote Setpoint**

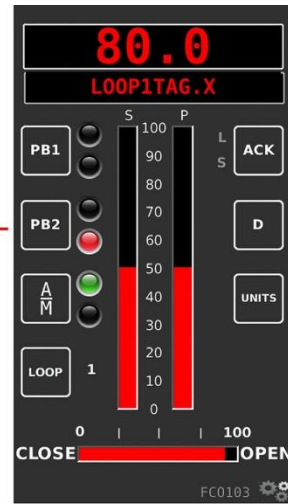

Select

**Auto Remote Setpoint
View Remote Setpoint**

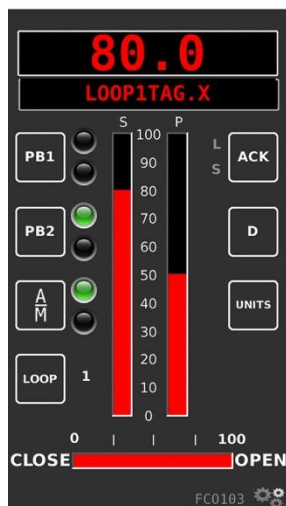

Select

**Auto Remote Setpoint
View Active Setpoint**

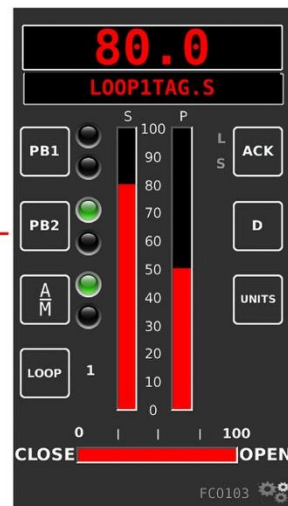

Select

Select **PB2** to change the setpoint source from local to remote. The LED to the right of **PB2** changes to **green**. Select **D** to change the value displayed in the numeric display to **S** (active setpoint). The active setpoint and remote setpoint are both 80.0.

Setpoint Tracking:

Some control strategies employ Setpoint Tracking.

In manual you can use **PB2** to select either local setpoint source or remote setpoint source for return to automatic mode. If you select local setpoint source the active setpoint tracks the process while in manual mode (you are not able to change the local setpoint). When you switch the controller back to auto mode, the setpoint source is local and will start at the process value for bumpless transfer. If you select remote setpoint source, the active setpoint tracks the remote setpoint while in manual mode. When you switch the controller back to auto mode, the setpoint source is remote.

**Manual Setpoint Track
Display Process**

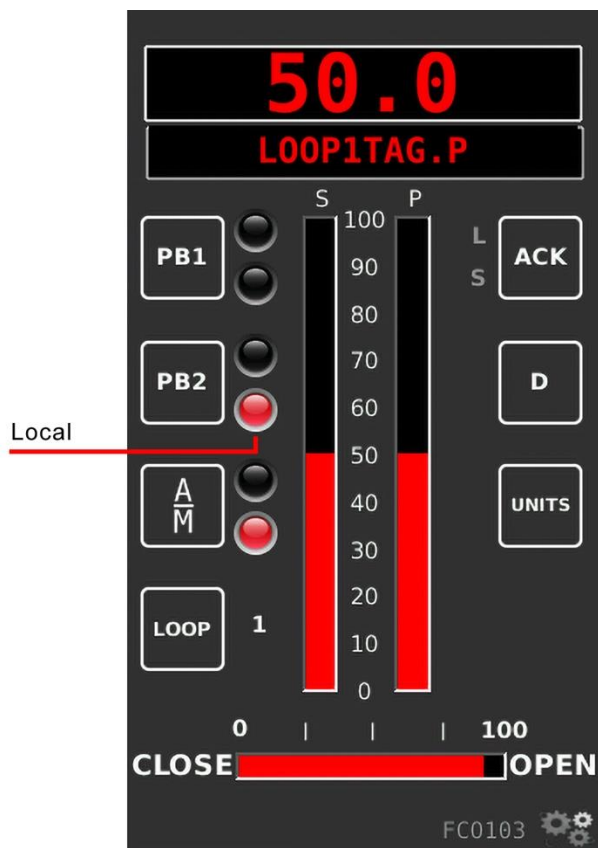

**Manual Setpoint Track
Display Setpoint**

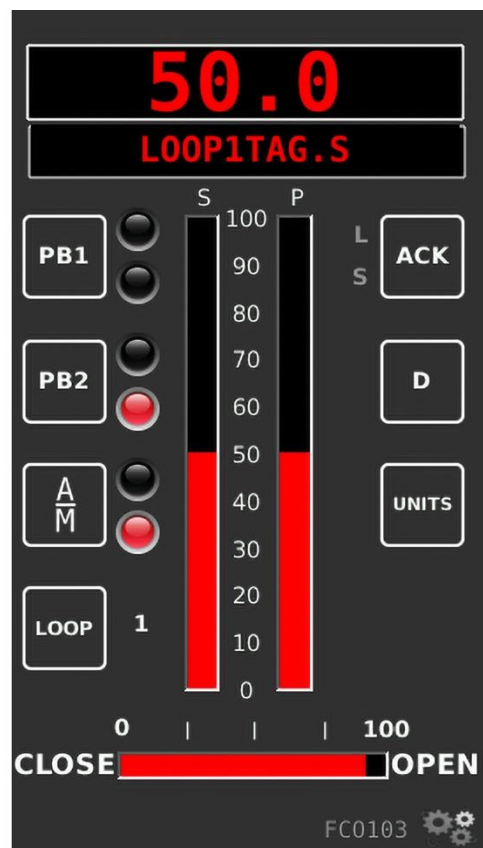



4.5 Change Output

To change the output - Use Up/Down Arrows or Keypad Entry

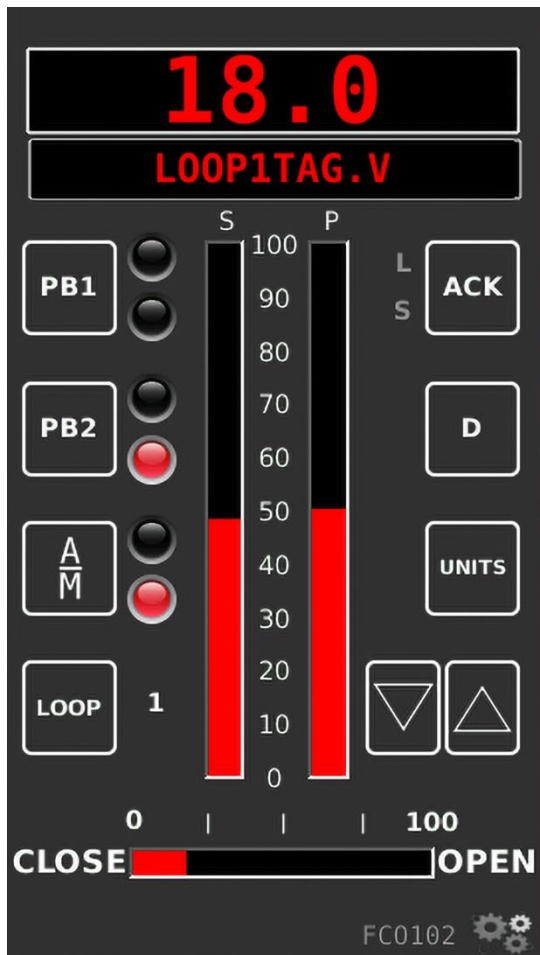
PID Analog Output Operate Display Manual Mode Output Shown in Numeric Display



The LED to the right of  indicates the controller mode, red for manual, green for auto. Select A/M to change the mode to manual.

Select  to display *LOOP1TAG.V* in the numeric display.

Use the Up/Down Arrows  to increase or decrease the Output. The rate of change of the value increases if you depress and hold the arrow.

Keypad

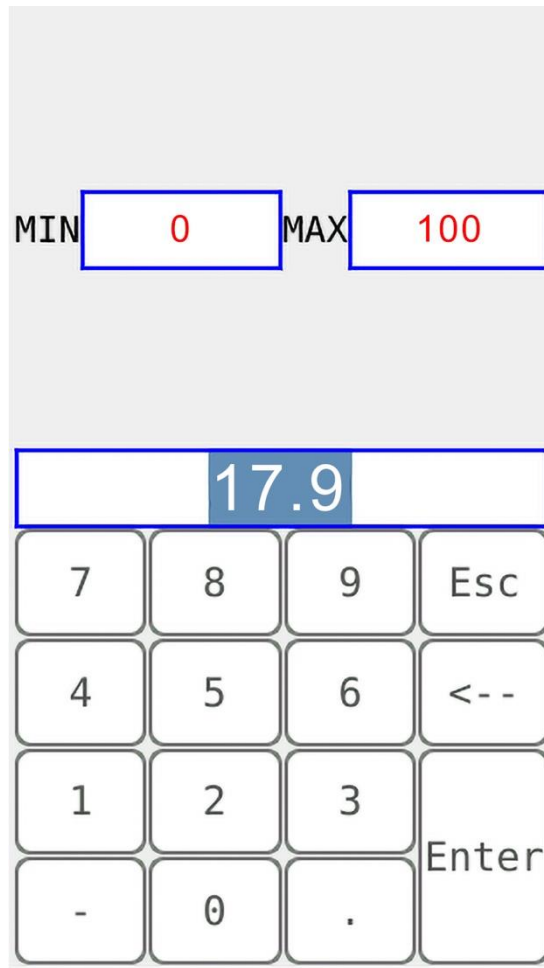

The **current value** is backlit and highlighted on the Numeric Display. The Cursor flashes to the right of the current value. Select characters on the keypad to input data. Select *Escape* to ignore the characters selected to return to the *Control Display*. Select the **Delete Character** < - - to delete the last character selected and move the cursor to the left. After you have input all the characters, select **Enter** to return to the *Control Display*.

5.0 Control Display - Type B

This is the primary Display for the operator.

5.1 PID Analog Output

Operate Display Auto Mode Setpoint Shown in Lower Numeric Display

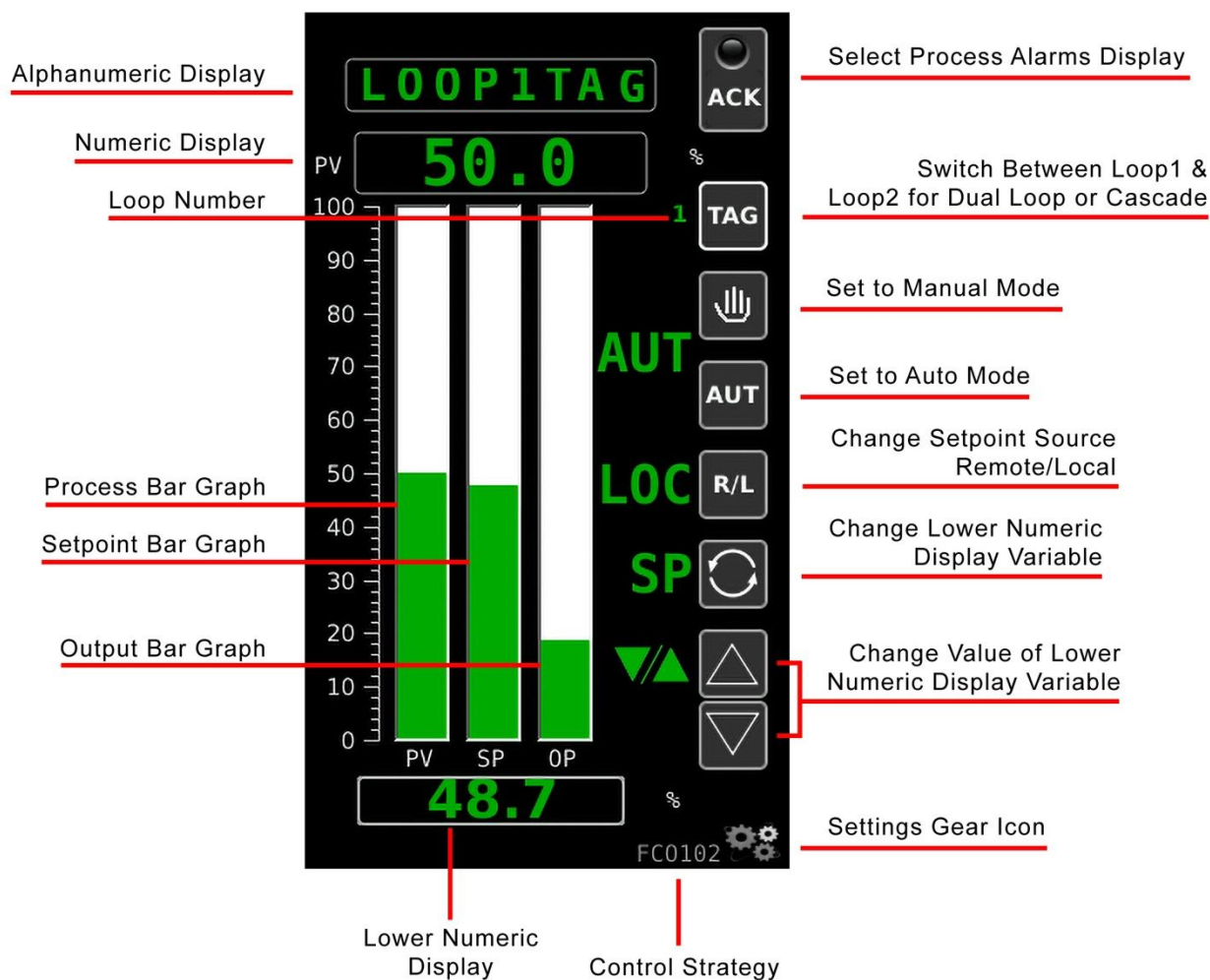

5.2 On/Off Control Digital Output

Operate Display Auto Mode
Output Shown in Lower Numeric Display

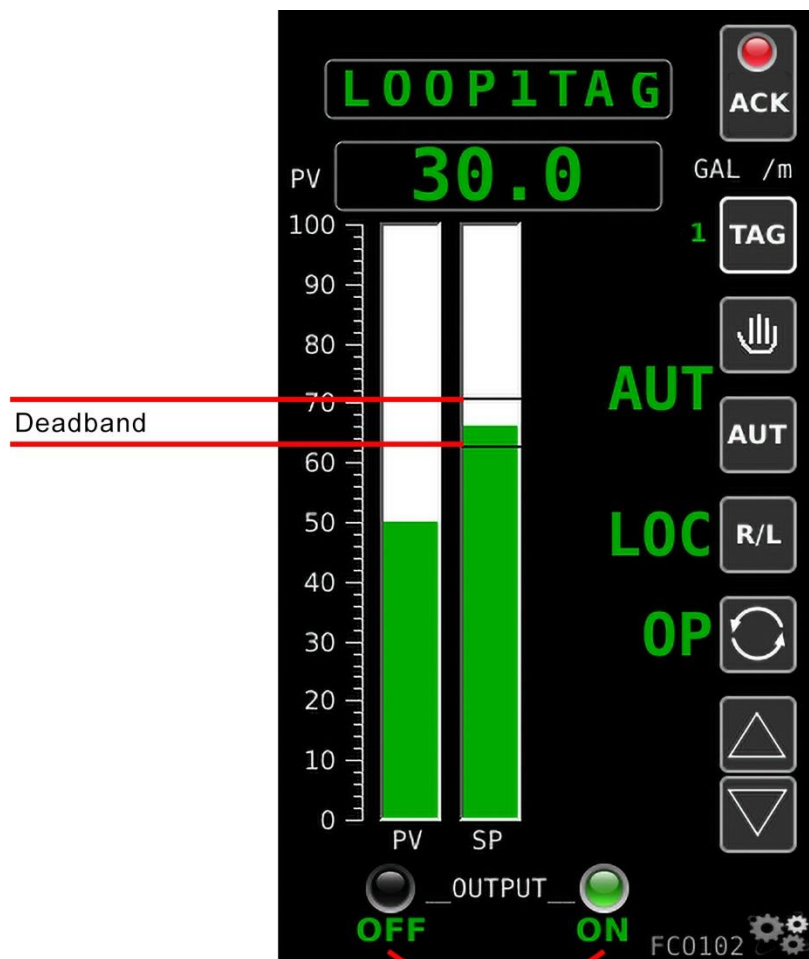

ON/OFF Control Digital Output Status

8-Character Alphanumeric Display - displays the Loop Tag of the variable currently showing in the 6-digit numeric display. A Loop Tag that is displayed is called the *Active Loop* and all operator controls (e.g. **ACK**, **TAG**, **HAND**, **AUTO**, **R/L**, **A/M**) will affect the function blocks within the *Active Loop*. The most recent highest priority unacknowledged alarm will be displayed for 2 seconds and alternate with the loop Process variable.

6-Digit Numeric Display - displays the numeric value of the Process Variable identified by the 8-character alphanumeric display. It supports up to 6 significant digits, regardless of the decimal point position. Examples: -999999 to 999999, -9999.99 to 9999.99. Any input exceeding limits flash and show as the maximum or minimum displayable value.

ACK and Status Indicator - are used to manage alarms. Alarms are assigned priorities 1-5 (with 1 the highest) and are organized within the controller, first by priority and then by order of occurrence. The Status Indicator light is used to indicate an alarm for the loop, including bad data quality.

Priorities

Priority 1 High Priority - causes the Controller bar graphs and LEDs to flash and requires acknowledgement to stop flashing. This is the highest priority.

Priority 2 - also flashes the bar graphs but stops flashing when the alarm clears (eg, self-clearing).

Priority 3 - also causes the alarm LEDs to flash and stops when the alarm is acknowledged.

Priority 4 - causes the alarm LEDs to flash but stops when the alarm clears.

Priority 5 - displays the alarm but not require acknowledgement. This is the lowest priority.

If the alarm is in the active loop, the alphanumeric display will alternate between the Loop Tag and the unacknowledged condition (e.g. 'TC2053' <---> 'A3 HI'). To open the Process Alarms Display, select **ACK**. Refer to Process Alarms Display Section for an explanation of the Process Alarms Display.

TAG - selects the *Active Loop* when more than one loop has been configured. **LOOP** advances the operator display to the next *Active Loop*. All operator controls now affect the *Active Loop* that is currently shown in the alphanumeric display (e.g. **FC2367**). When a loop is first displayed, the loop tag will appear in the alphanumeric field and the displayed variable will be the same as when the loop was last viewed.

Hand and **AUT** - control the operation of an **A/M (Auto/Manual)** function block. The mode is displayed as manual (**MAN**) or auto (**AUTO**). Selecting **Hand** changes the mode to manual. The Output Value is displayed in engineering units on the lower numeric display. The Output Value can be adjusted by either using the **Up/Down Arrows** or by selecting the lower numeric display and entering a value (if keypad entry was enabled during Setup.) Selecting **AUT** changes the mode to auto. The Setpoint Value is displayed in engineering units on the lower numeric display. The Setpoint Value can be adjusted using the **Up/Down Arrows** or by selecting the lower numeric display and entering a value (if the Keypad Entry was enabled during Setup).

R/L - PB2SW (PB 2 transfer SWitch) function block controls local or remote setpoint source when the block has been configured for use within the *Active Loop*. Refer to the Control Strategies Details Section for more information on **PB2SW**. Selecting **R/L** toggles Local and Remote Setpoint source. The Setpoint source is indicated to the left of **R/L** as either LOC, REM, or **LOC/REM** (if the setpoint is tracking). If local setpoint is the value selected for the lower numeric display and the controller is in auto mode, the setpoint value can be changed with the **Up/Down Arrows** or by selecting the lower numeric display and entering a value.

Scroll - (two counterclockwise arrows). Select to switch to display either SP, OP, X, Y, or RAT, on the lower horizontal bar graph. Note: X, Y, and RAT variables will only appear for certain Control Strategies. The X, Y, and RAT values can also be selected (and possibly changed) if they apply to the active Control Strategy.

Up/Down Arrows - use the Up and Down arrows to change the value in the numeric display (e.g. **Setpoint**, **Output**, or other variable configured for normal operator display changes such as **Ratio**). The rate of change of the value increases if you depress and hold the arrow. The **Up/Down Arrows** are only visible if it possible to change the value in the numeric display.

Process Bar graph - this vertical bar graph displays the scaled range of the controller process in the *Active Loop*. Bar graph height shows the process as the % of range value.

Setpoint Bar graph - this vertical bar graph displays the scaled range of the controller setpoint in the *Active Loop*. Bar graph height shows the setpoint as the % of range value.

Deadband Indication - these horizontal lines indicate the deadband for PID Digital Outputs. Deadband is the hysteresis as a % for ON/OFF control. For example, AI1 range 0 to 200F, deadband = 4%, Direct Mode, setpoint = 100F. DO goes ON below 96F and OFF above 104F. This is much like a home thermostat.

Output Bar graph - for analog PID control output, this vertical bar graph displays the scaled range of the controller output in the *Active Loop*. Bar graph height shows the output as the % of range value. For ON/OFF Control digital outputs, OFF or ON will be displayed.

Gear Icon - Select to open *Main Menu Display*.





5.3 Change Local Setpoint

This section applies to the Local setpoint. The remote setpoint (if used in the control strategy) can be viewed but not changed by an operator.

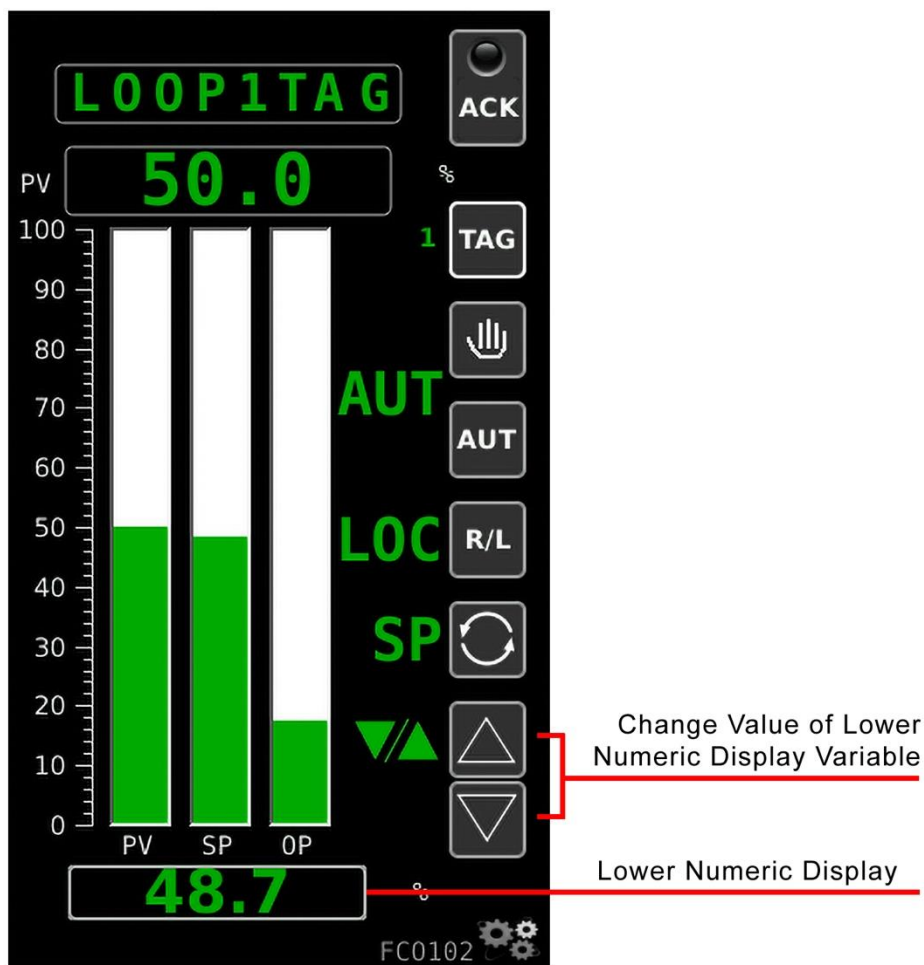
To change the Local Setpoint - Use Up/Down Arrows or Keypad Entry

Operate Display Auto Mode
Local Setpoint Shown in Lower Numeric Display



The text to the left of the  symbols indicates the controller mode, MAN for manual, AUT for auto. Select  to change the mode to auto. The text to the left of  shows the value displayed in the lower numeric display, either SP (setpoint) or OP (output). Select  to show SP. Use the Up/Down Arrows to increase or decrease the setpoint. The rate of change of the value increases if you depress and hold the arrow.

To enter a local setpoint value using the keypad, select the Numeric Display to Open the *Keypad Display* (if keypad entry was enabled during Setup).

Keypad

The **current value** is backlit and highlighted on the Numeric Display. The Cursor flashes to the right of the current value. Select Characters on the keypad to input data.

Select **Escape** to ignore the characters selected to return to the *Control Display*.

Select the **Delete < - -** Character to delete the last character selected and move the cursor to the left.

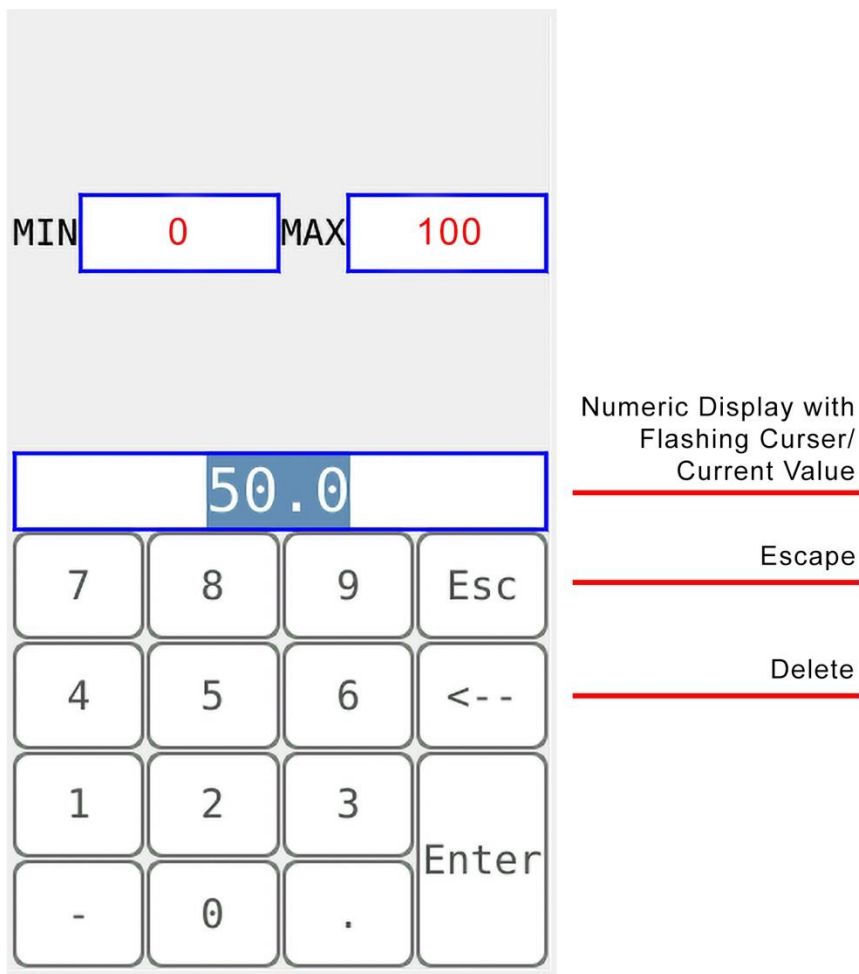

Note that the **MIN** and **MAX** values may be different depending on your control strategy.

Select **Enter** after you have input all the characters to return to the *Control Display*.

5.4 Remote Setpoint



The remote setpoint (if used in the control strategy) can be viewed but not changed by an operator.

The indication of remote setpoint changes depending on whether or not setpoint tracking was enabled.

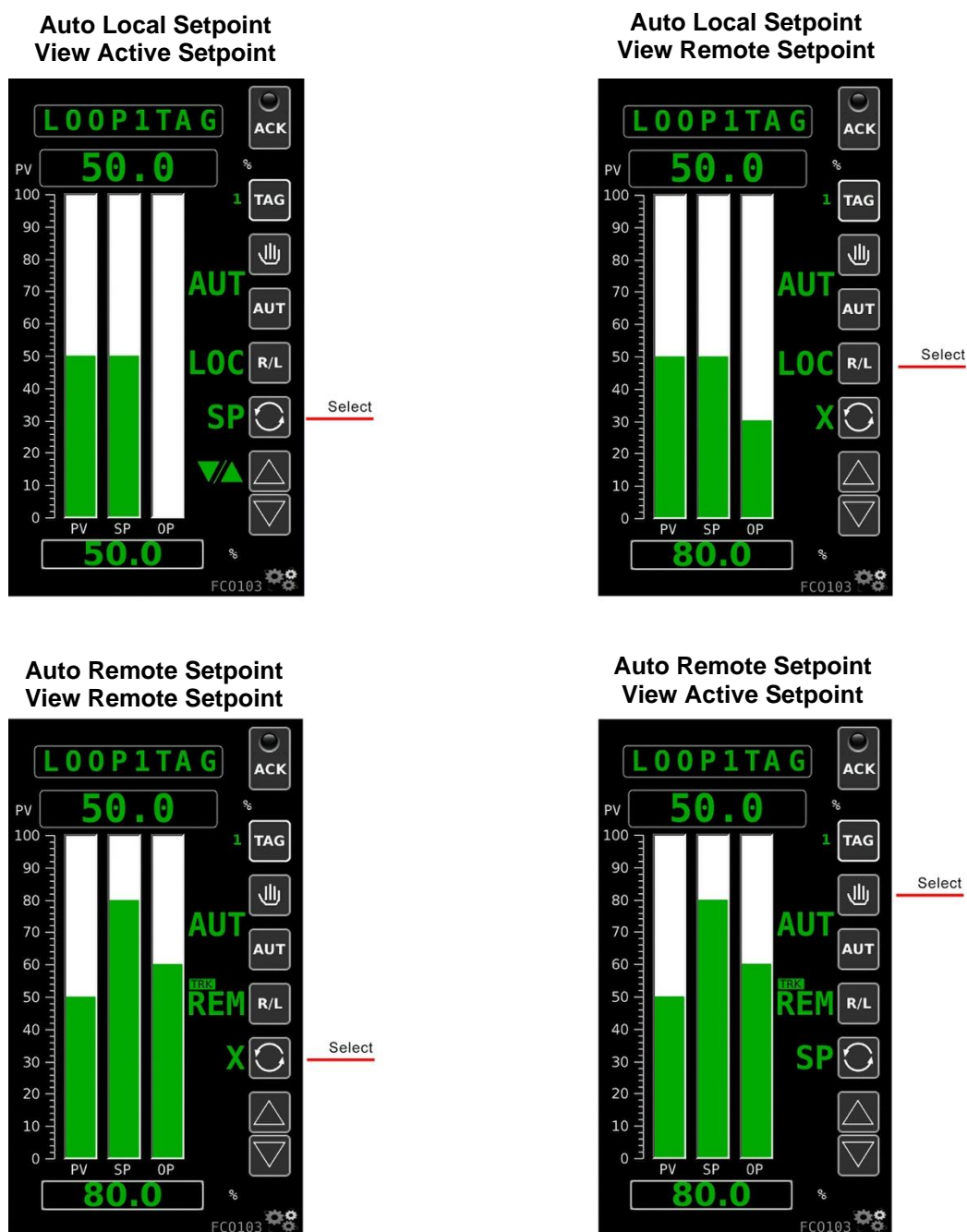
Setpoint Tracking Enabled



Select  to change the value displayed in the lower numeric display to **X** (remote setpoint).

Select  to change the setpoint source from local to remote. **LOC** immediately changes to **REM**. Select  to display **SP** (active setpoint). The active setpoint and remote setpoint are both 80.0 %.

Select  to change the mode from auto to manual.

Manual SP Track Remote

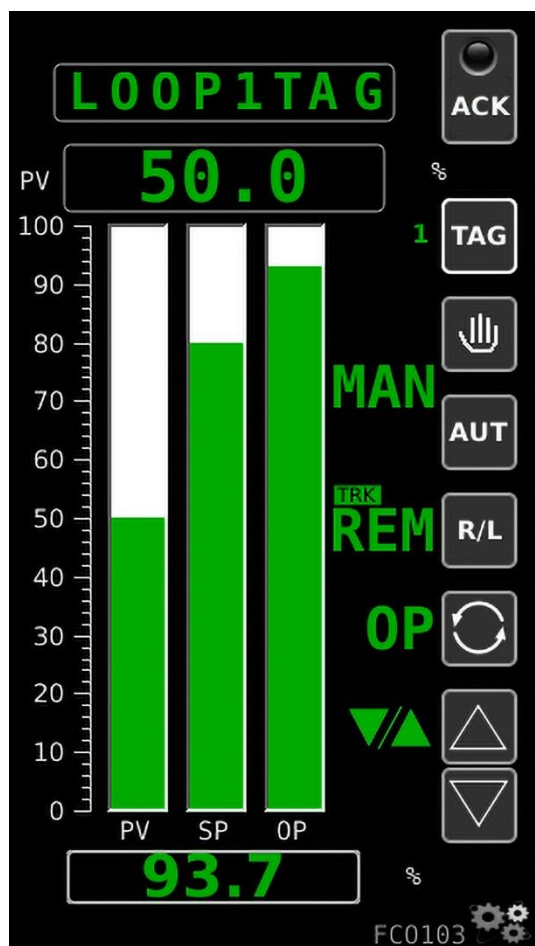

Manual SP Track Process

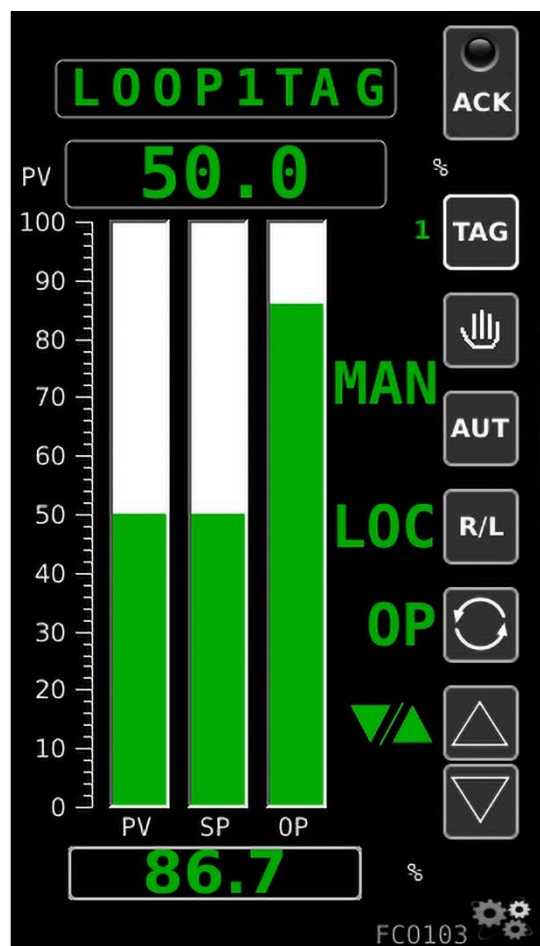

Select

In manual you can use  to select either **LOC** local setpoint source or **REM** to select remote setpoint source. If you select local setpoint source the active setpoint tracks the process in manual mode (you cannot change the setpoint). When you switch the controller back to auto mode, the setpoint source is local and will start at the process value for bumpless transfer. If you select remote setpoint source, the active setpoint tracks the remote setpoint in manual mode. When you switch the controller back to auto mode, the setpoint source is remote.

Setpoint Tracking Disabled

**Auto Local Setpoint
View Active Setpoint**

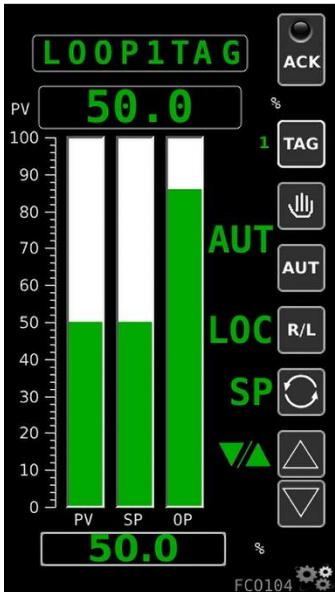

**Auto Local Setpoint
View Remote Setpoint**

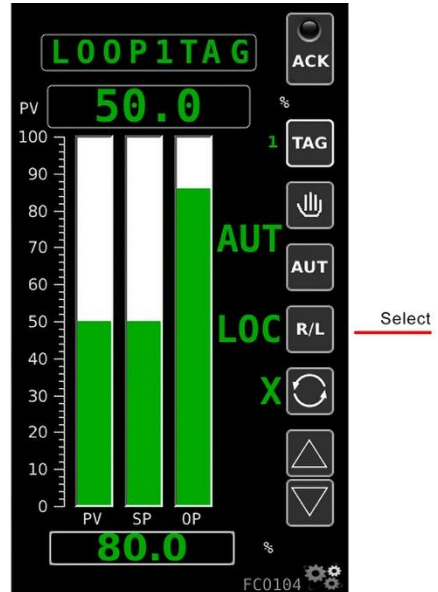

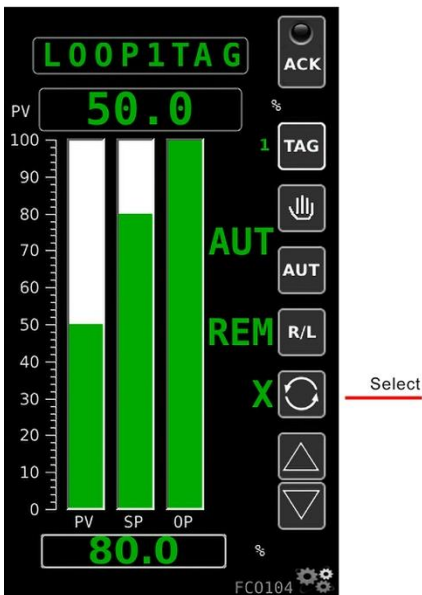

**Auto Remote Setpoint
View Remote Setpoint**

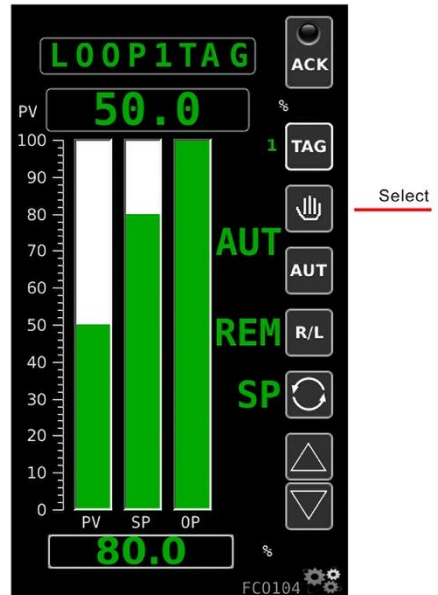

**Auto Remote Setpoint
View Active Setpoint**



Select  to change the value displayed in the lower numeric display to **X** (remote setpoint).

Select  to change the setpoint source from local to remote. **LOC** immediately changes to **REM**. Select  to display **SP** (active setpoint). The active setpoint and remote setpoint are both 80.0 %.

Select  to change the mode from auto to manual.

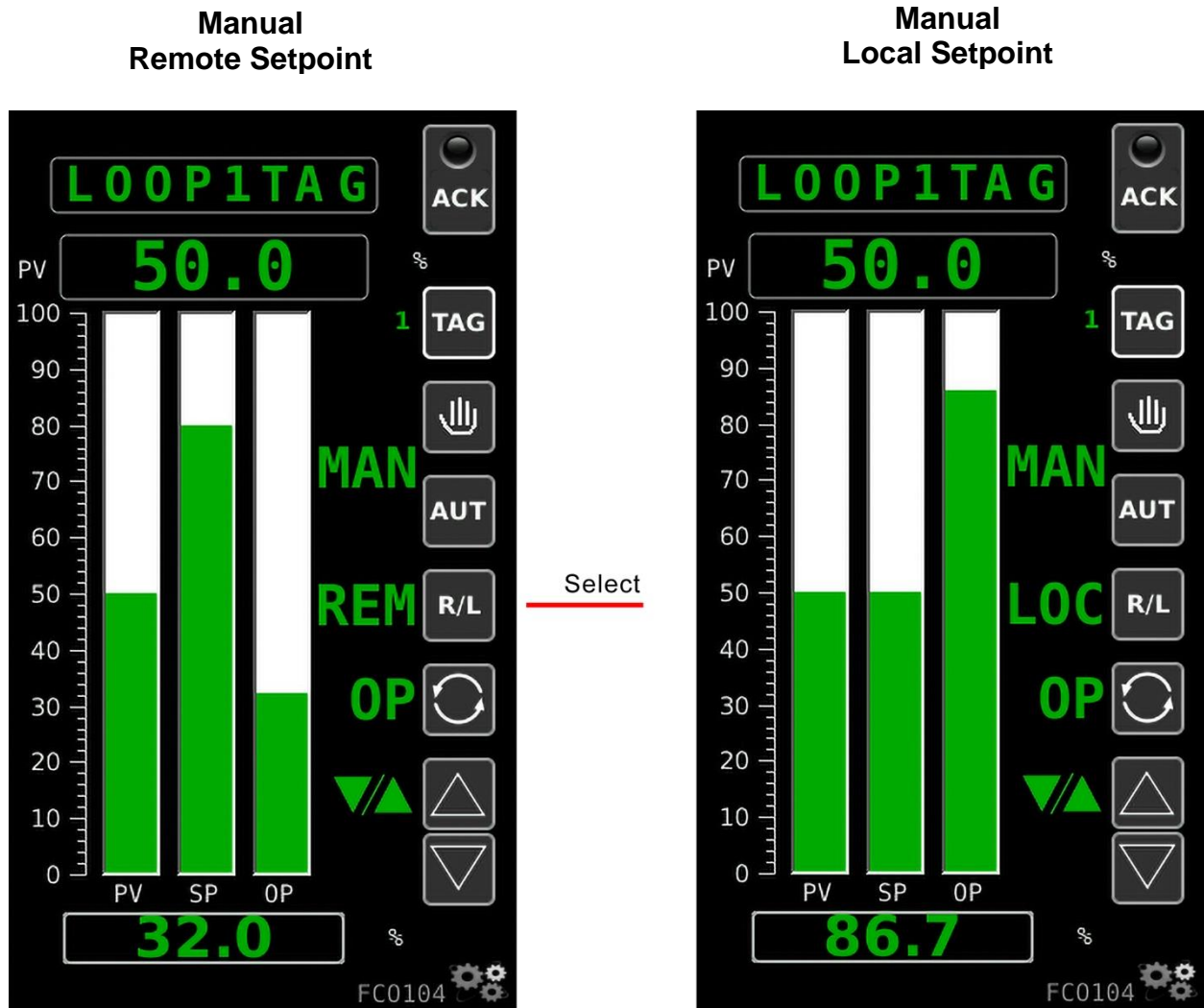





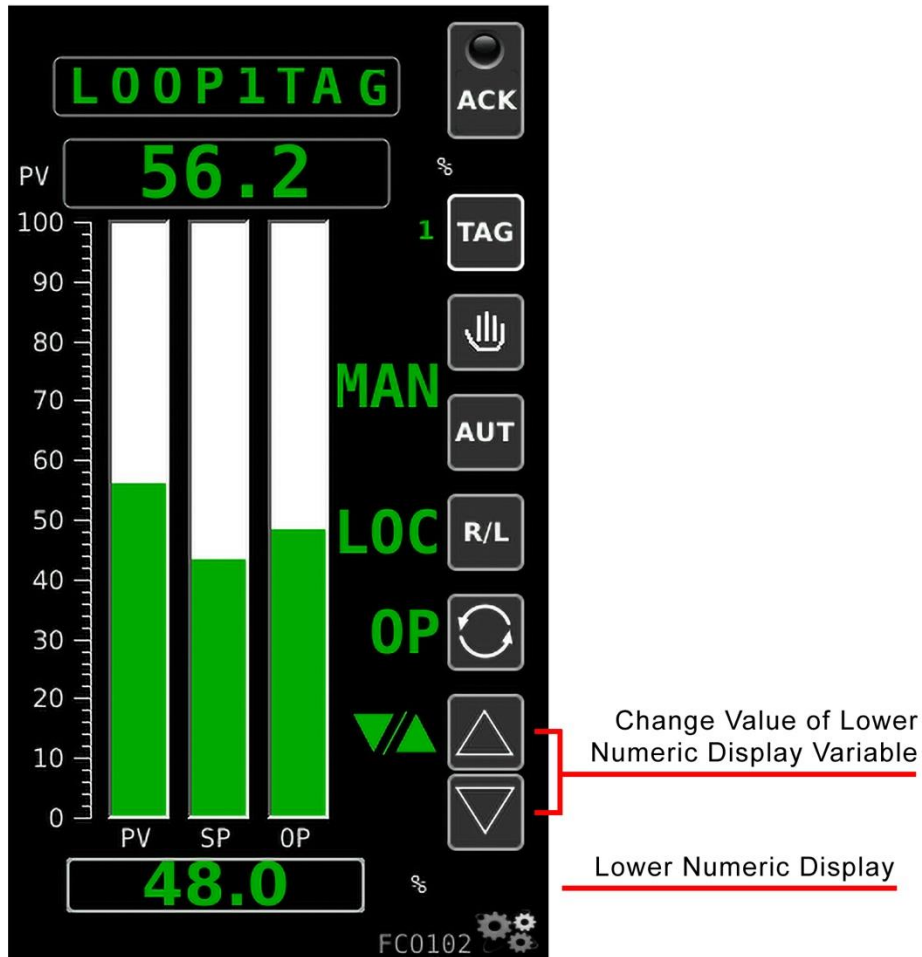

In manual, if you select local setpoint source, when you switch the controller back to auto mode, the setpoint source is local and will start at whatever value the operator enters. If you select remote setpoint source, the setpoint source is remote.

5.5 Change Output

Change Output - Use Up/Down Arrows or Keypad Entry

Operate Display Manual Mode
Output Shown in Lower Numeric Display



The text to the left of the   symbols indicates the controller mode, MAN for manual, AUT for auto. Select  to change the mode to MAN. The text to the left of  shows the value displayed in the lower numeric display, either SP (setpoint) or OP (output). Select  to show OP. Use the Up/Down Arrows to increase or decrease the output. The rate of change of the value increases if you depress and hold the arrow.

To enter an output value using the keypad, select the Numeric Display to Open the *Keypad Display* (if keypad entry was enabled during setup.)

Keypad



The **current value** is backlit and highlighted on the Numeric Display. The Cursor flashes to the right of the current value. Select characters on the keypad to input data.

Select **Escape** to ignore the characters selected to return to the *Control Display*.

Select **Delete Character < - -** to delete the last character selected and move the cursor to the left. After you have input all the characters, select *Enter* to return to the *Control Display*.

6.0 Support

The *Support Contact Popup Display* shows who to contact for technical support for the controller. The default is Classic Automation LLC.



7.0 Control Strategies Details

FCO101	Single Loop Control w/ Tracking Setpoint
FCO102	Single Loop Control w/ Fixed Setpoint
FCO103	External Set Control w/ Tracking Local Setpoint
FCO104	External Set Control w/ Non-Tracking Local Setpoint
FCO105	Ratio Set Control w/ Operator Setpoint Limits
FCO106	Single Loop Control w/ Operator Setpoint Limits
FCO107	Dual Loop Control
FCO121	Cascade Control
FCO122	Cascade Control w/ Operator Setpoint Limits

For Ratio Control, the local setpoint can be changed when the mode is auto and the setpoint source is local. The ratio may or may not be adjustable depending on whether tracking was enabled. Refer to *Loop Configuration Display* in *Panelicity Setup Guide*.

For Cascade Control, Loop 1 will track until Loop 2 is in Auto with a remote setpoint. You cannot put Loop 1 into Auto until Loop 2 is in Auto with Remote Setpoint source.

Block Diagram and description for the Control Strategy shows how the controller functions. It is not necessary to understand the Block Diagram in detail but rather to understand the overall function of the controller. The red flag points in the diagram indicate parameters that are shown on the *Operator Display*. The following describes the functionality of each Control Strategy:

FCO101 - Single Loop Controller w/ Tracking Setpoint

Factory Configured Option FCO101 provides a single loop controller configured in Loop01. A block diagram of the loop configuration is shown below along with any changes to the default parameter values of the configured blocks. This configuration provides setpoint tracking which will cause the setpoint to track the process when the loop is not in Auto (NA). If the loop tag 'Loop01' is changed, all configured references within the station will automatically be changed to the new tag.

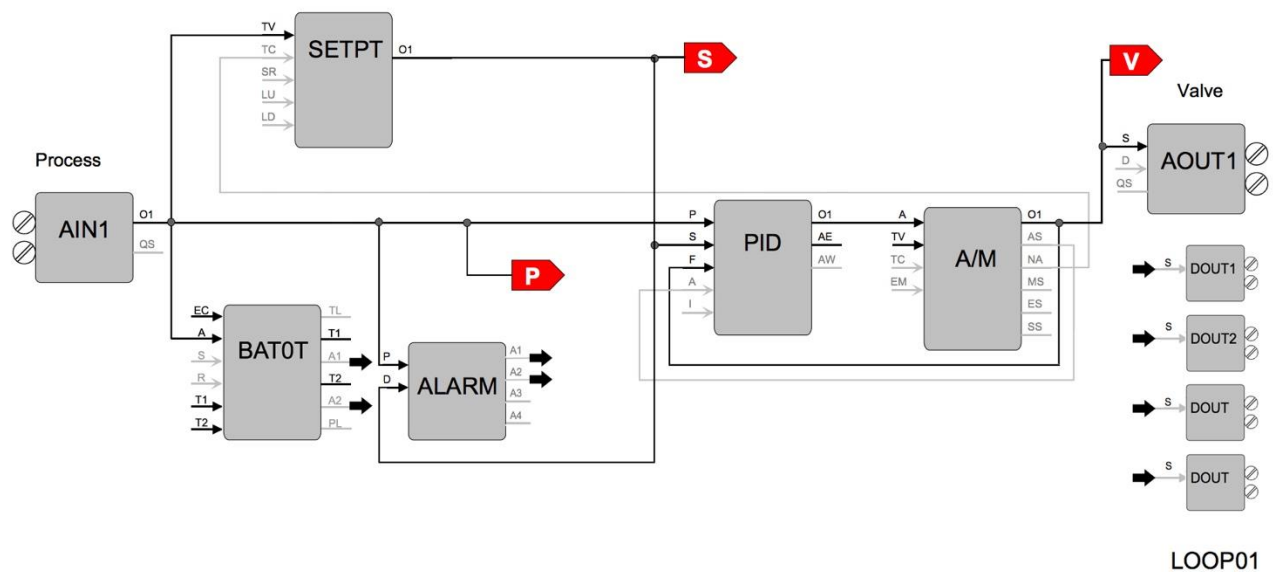

P is the Process Value
S is the Setpoint Value
V is the Output Value

FCO102 - Single Loop Controller w/ Fixed Setpoint

Factory Configured Option FCO102 provides a single loop controller configured in Loop01. A block diagram of the loop configuration is shown below along with any changes to the default parameter values of the configured blocks. If the loop tag 'Loop01' is changed, all configured references within the station will automatically be changed to the new tag.

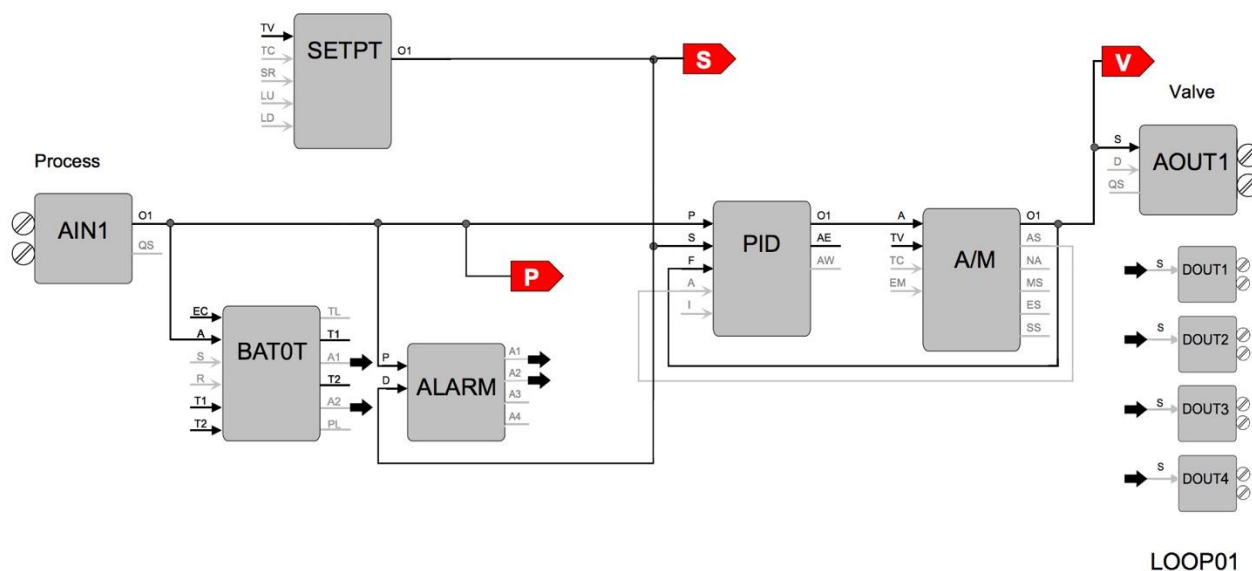

P is the Process Value
S is the Setpoint Value
V is the Output Value

FCO103 - External Set Controller w/ Tracking Local Setpoint

Factory Configured Option FCO103 provides a single loop controller with external setpoint configured in Loop01. A block diagram of the loop configuration is shown below along with any changes to the default parameter values of the configured blocks. This configuration provides setpoint tracking. If a fixed setpoint is desired, the TC input to the SETPT function block can be set to UNCONFIG. If the loop tag 'LOOP01' is changed, all configured references will automatically be changed to the new tag.

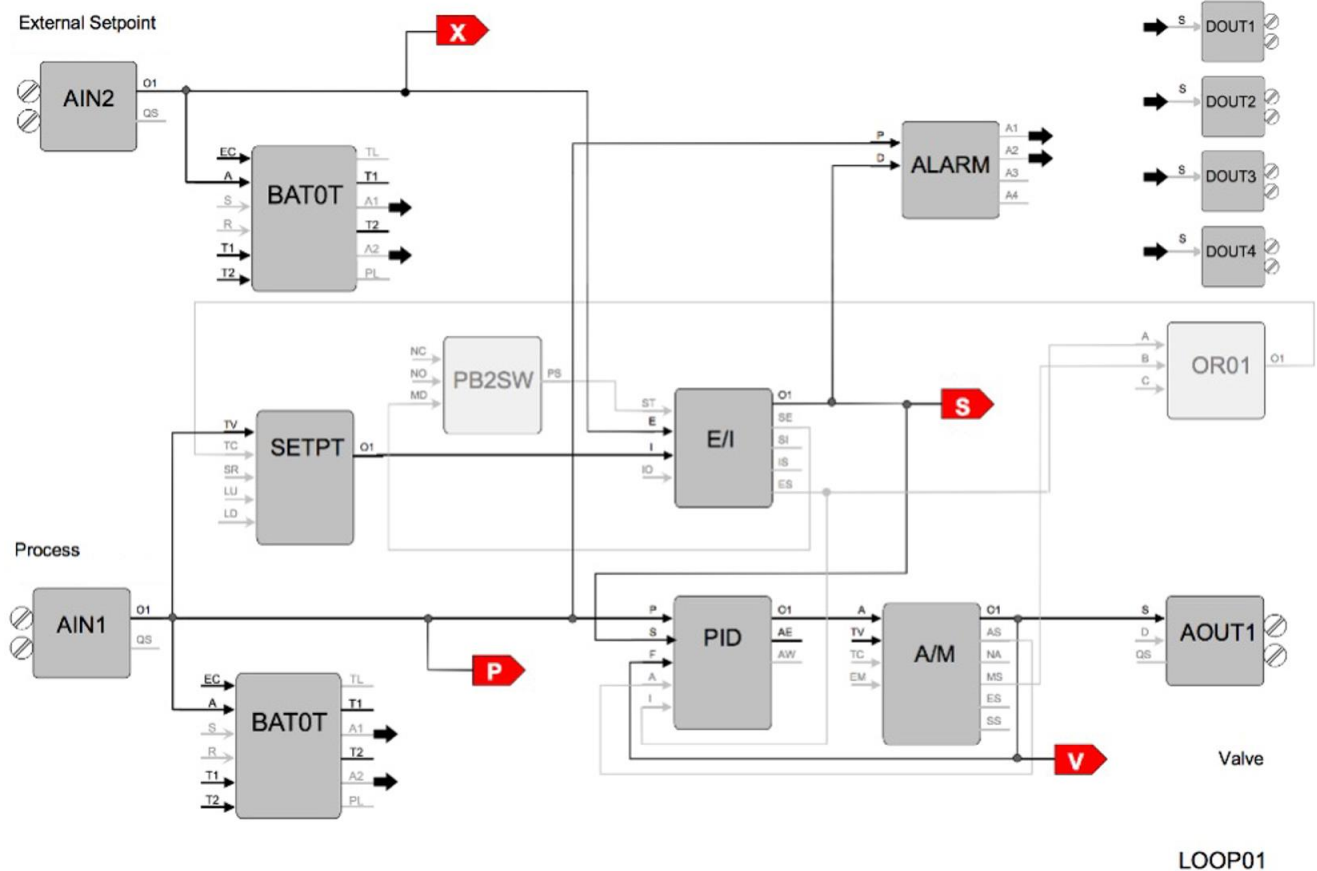

FCO104 - External Set Controller w/ Non-Tracking Local Setpoint

Factory Configured Option FCO104 provides a single loop controller with external setpoint configured in Loop01. A block diagram of the loop configuration is shown below along with any changes to the default parameter values of the configured blocks. If the loop tag 'LOOP01' is changed, all configured references will automatically be changed to the new tag.

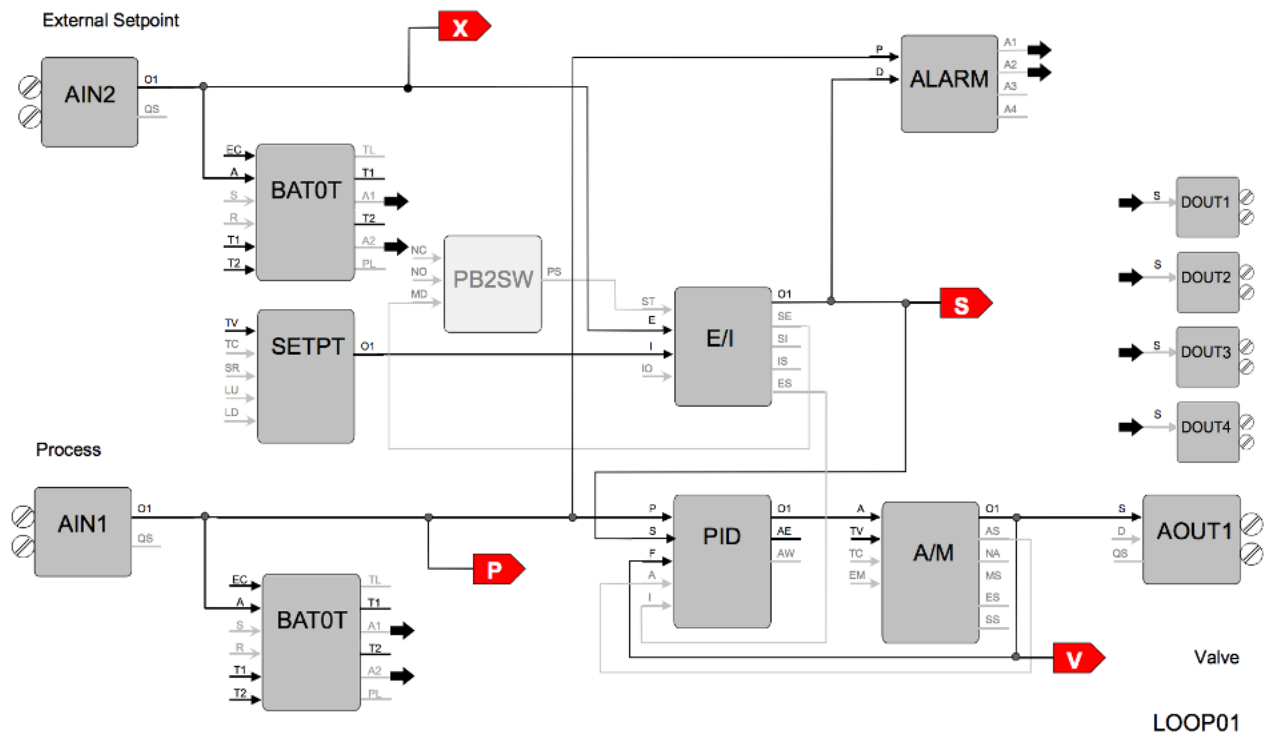

P is the Process Value
S is the Setpoint Value
V is the Output Value
X is the External Setpoint Value

FCO105 - Ratio Set Control w/ Operator Setpoint Limits

Factory Configured Option FCO105 provides a ratio set controller in Loop01. The setpoint to the Captive Flow controller can be maintained as a ratio of the Captive Flow to Wild Flow. The controller has complete setpoint tracking as well as ratio tracking. The local setpoint will track the Captive Flow signal when the loop is not in auto (NA) OR is in External (Ratio) Set (ES). The value of the RATIO will be computed as Captive Flow setpoint / Wild Flow while in the tracking mode which occurs whenever the loop is not in auto (NA) OR is in Internal Set (IS). The tracking features can be removed by setting the TC inputs to UNCONFIG. The Wild Flow signal will be displayed on Variable X and the actual Ratio CF/WF will be displayed on Variable Y.

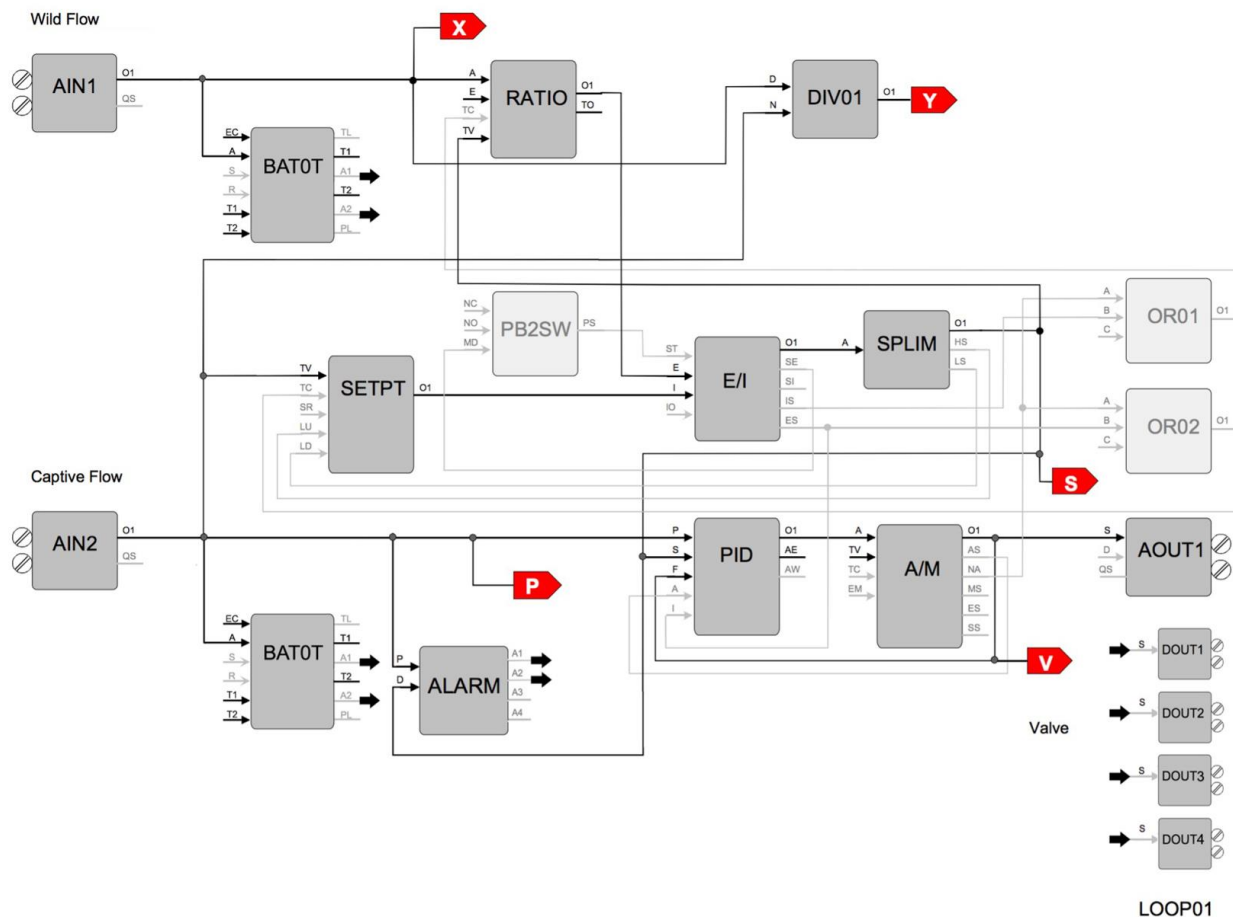

- P** is the Process Value
- S** is the Setpoint Value
- V** is the Output Value
- X** is the Wild Flow Value
- Y** is the ratio of Captive Flow/Wild Flow

FCO106 - Single Loop Controller w/ Operator Setpoint Limits

Factory Configured Option FCO106 provides a single loop controller configured in Loop01. This is similar to FCO101 but with a SPLIM block added to the output of the SETPT block. A block diagram of the loop configuration is shown below along with any changes to the default parameter values of the configured blocks. This configuration provides setpoint tracking. If a fixed setpoint is desired, the TC input to the SETPT function block can be set to UNCONFIG. If the loop tag 'LOOP01' is changed, all configured references will automatically be changed to the new tag.

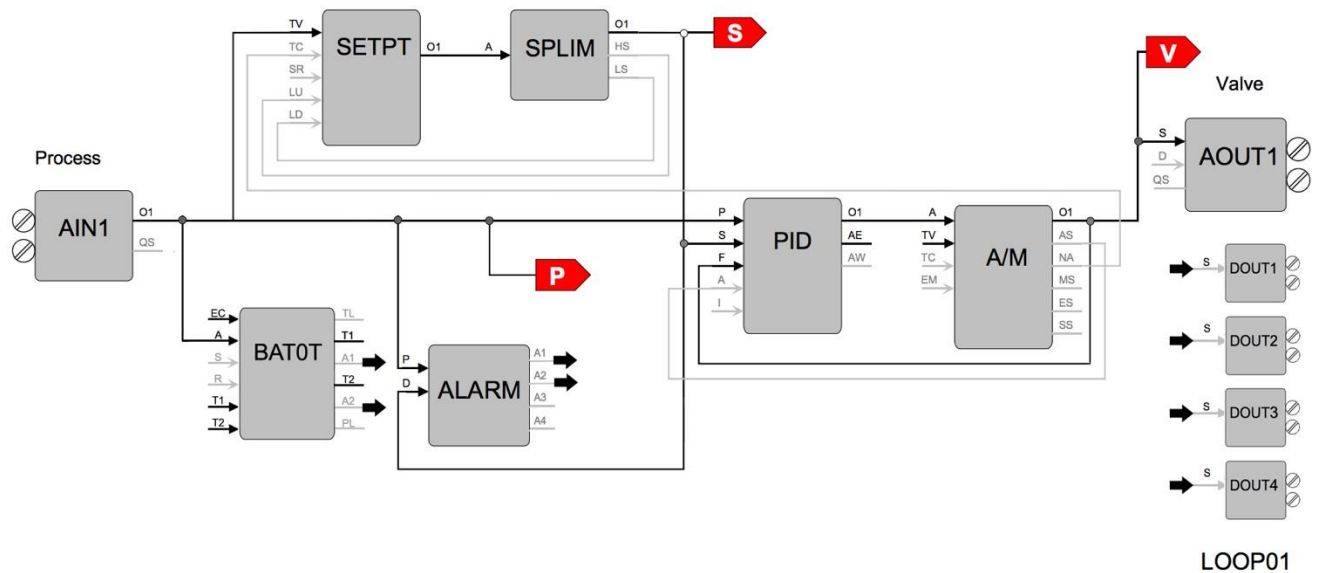

P is the Process Value
S is the Setpoint Value
V is the Valve (Output)

FCO107 - Dual Loop Controller

Factory Configured Option FCO107 provides two independent loops with tracking setpoints. The block diagram of the configuration of the two loops is shown below along with the changes made to the default parameter values of the configured blocks. This configuration provides setpoint tracking. If a fixed setpoint is desired, the TC input to the SETPT function block can be set to UNCONFIG. The process range of the first loop can be changed in Analog Input 1 and the range of the Second loop in Analog Input 2.

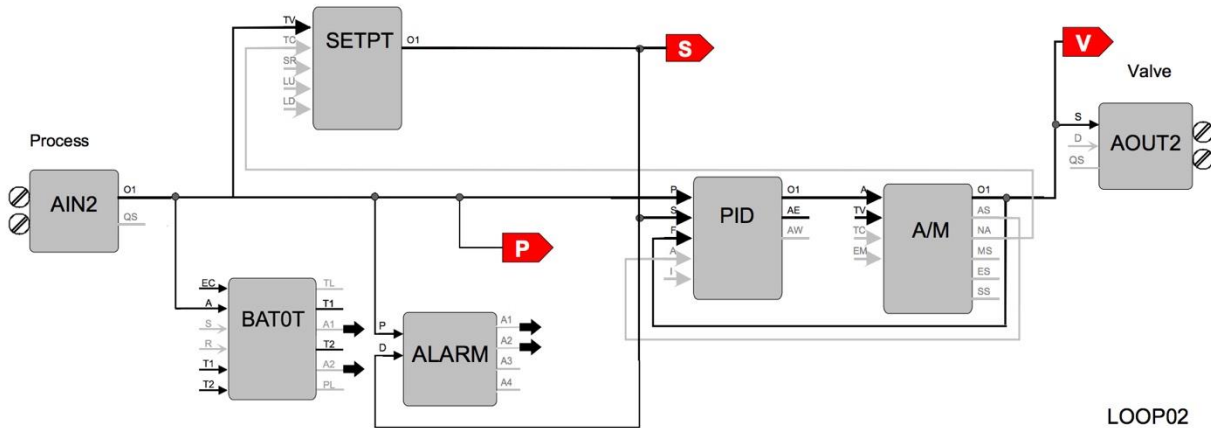
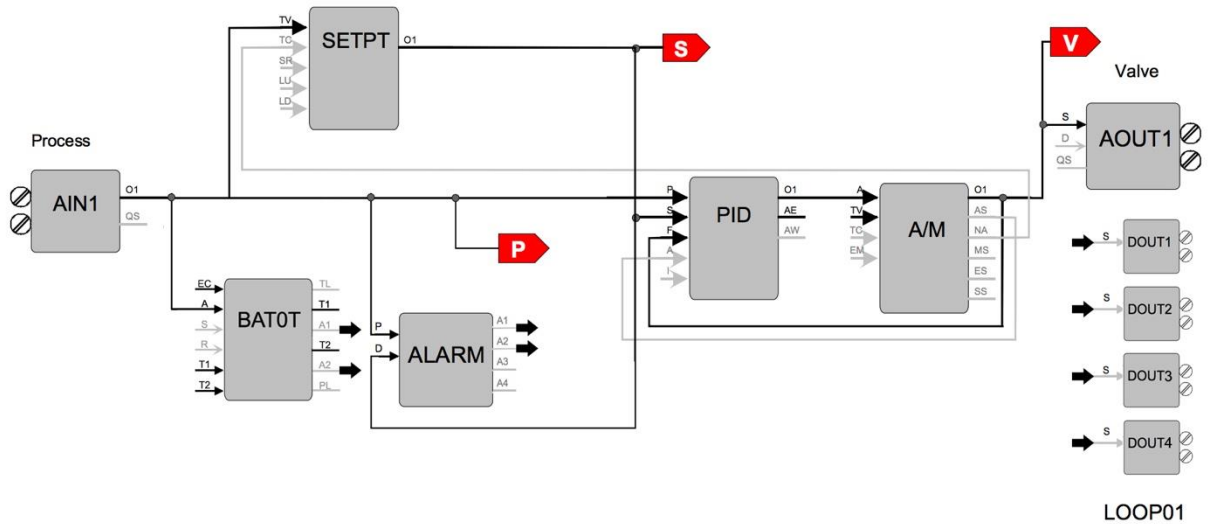

P is the Process Value
S is the Setpoint Value
V is the Output Value

FCO121 - Cascade Control

Factory Configured Option FCO121 provides two loops configured for Cascade control. The block diagram of the configuration of the two loops is shown below along with the changes made to the default parameter values of the configured blocks. The process range of the Primary loop can be changed in Analog Input 1 and the range of the Secondary loop in Analog Input 2. Also, the output range of the primary PID controller must be changed to match any new range in the secondary loop. If the loop tag 'PRIM' or 'SEC' is changed, all configured references will automatically be changed to the new tag.

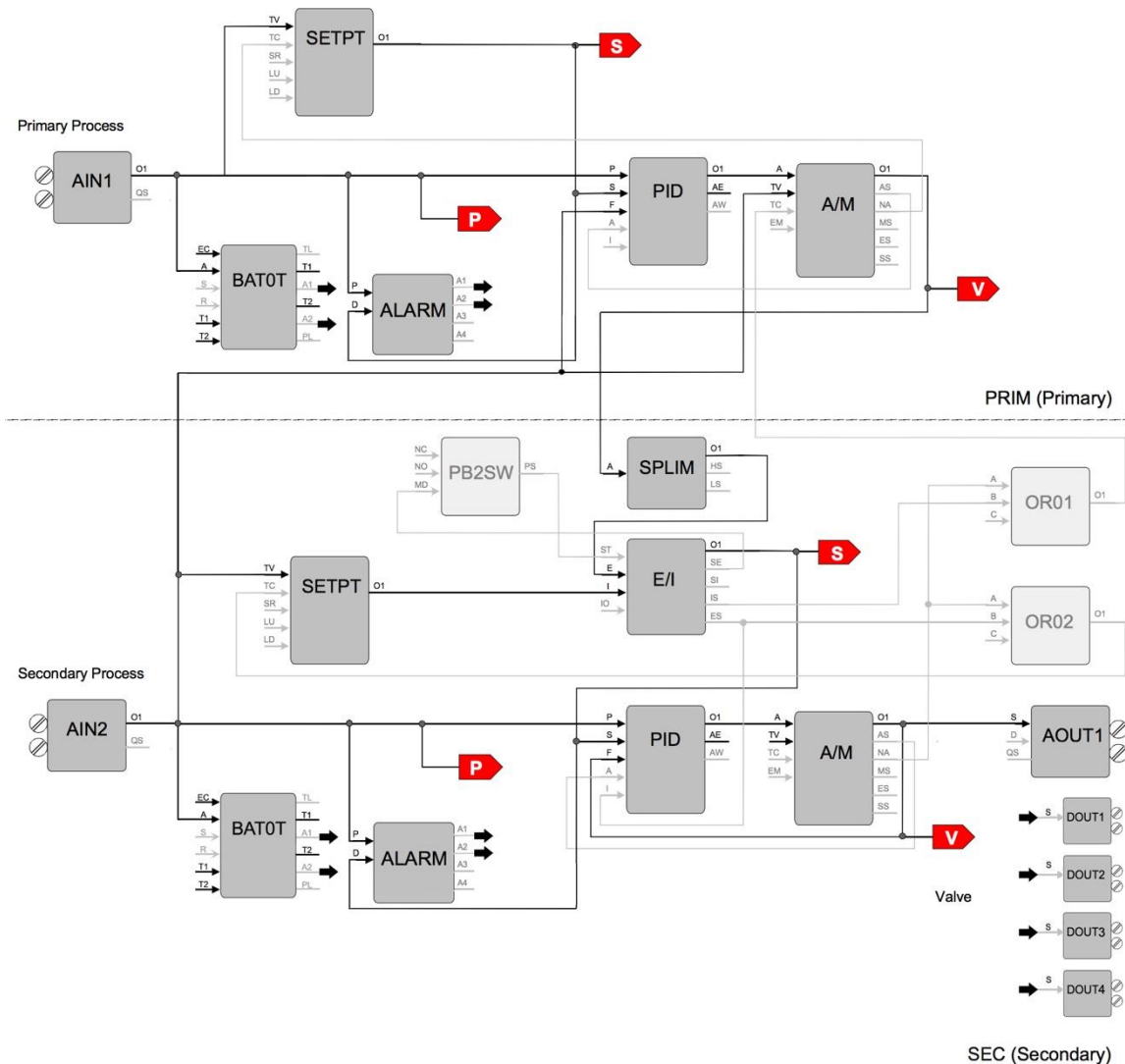

P is the Process Value
S is the Setpoint Value
V is the Output Value

FCO122 - Cascade Control w/ Operator Setpoint Limits

Factory Configured Option FCO122 provides two loops configured for Cascade control. The block diagram of the configuration of the two loops is shown below along with the changes made to the default parameter values of the configured blocks. The process range of the Primary loop can be changed in Analog Input 1 and the range of the Secondary loop in Analog Input 2. Also, the output range of the primary PID controller must be changed to match any new range in the secondary loop. If the loop tag 'PRIM' or 'SEC' is changed, all configured references will automatically be changed to the new tag.

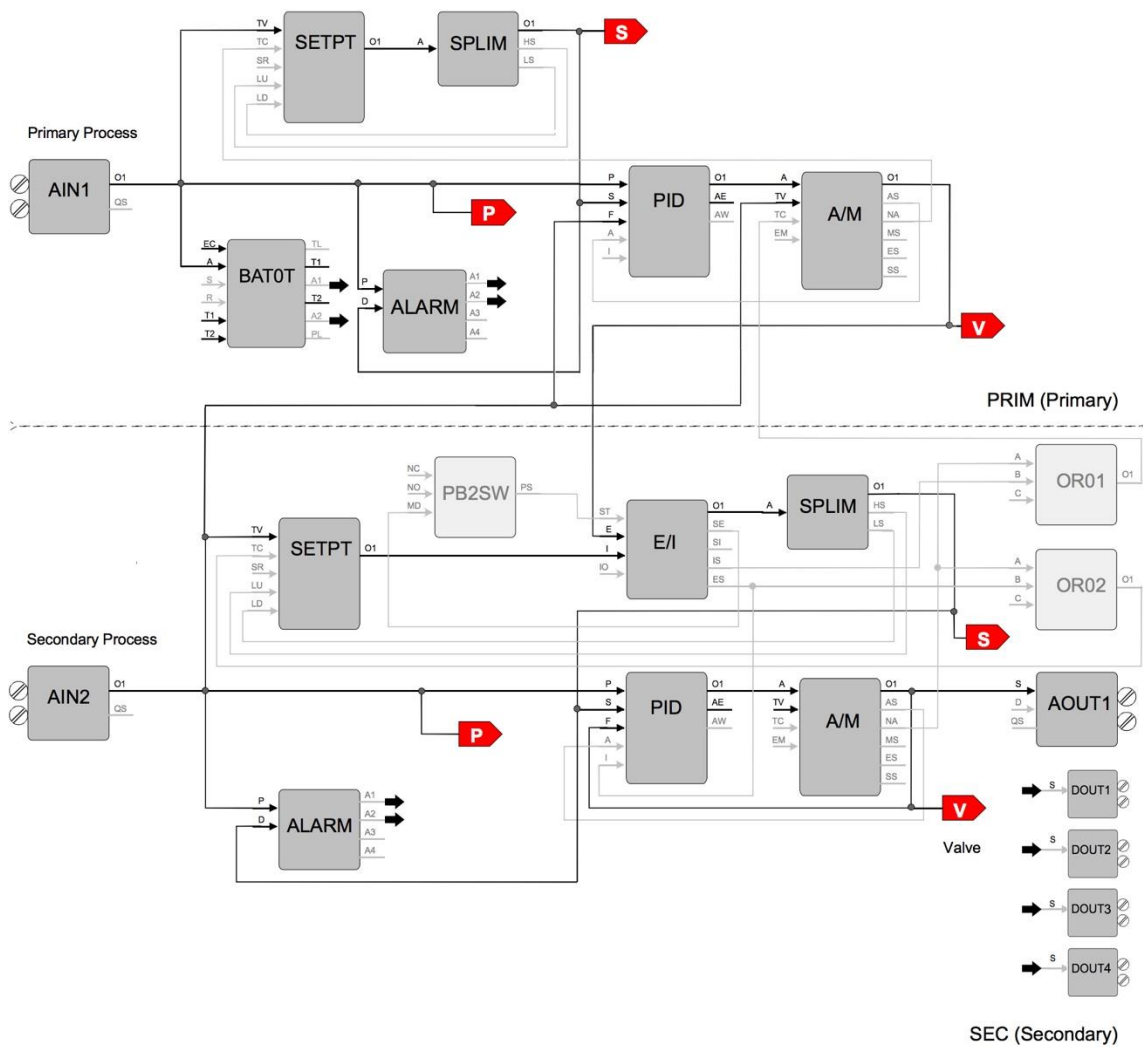

P is the Process Value
S is the Setpoint Value
V is the Output Value

Classic Automation LLC
800 Salt Road
Webster, NY 14580

+1 (585) 241-6010
www.Panelicity.com
CustomerService@classicautomation.com

DISCLAIMER: User Manual contents are subject to change without notice. Refer to revision history.